

C67

油式三相交流滤波电容器(一体)

Filled type three phase AC filter capacitor(Single case)

■ 外形图 Outline Drawing

帽式设计(Cap type design)

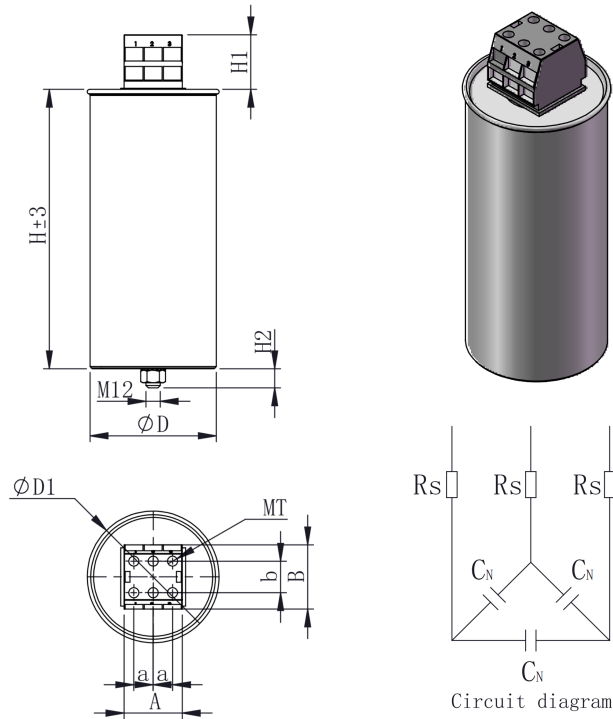

D±1	76~116	136
a±0.5	15	16.5
b±0.5	19.4	25
A±1	43.5	49
B±1	44.5	54.5
H1±2	35	45
H2±1	16	18
MT	M5	M6

帽式设计(带滚槽设计, D=116~136) Cap type design(Channeling)

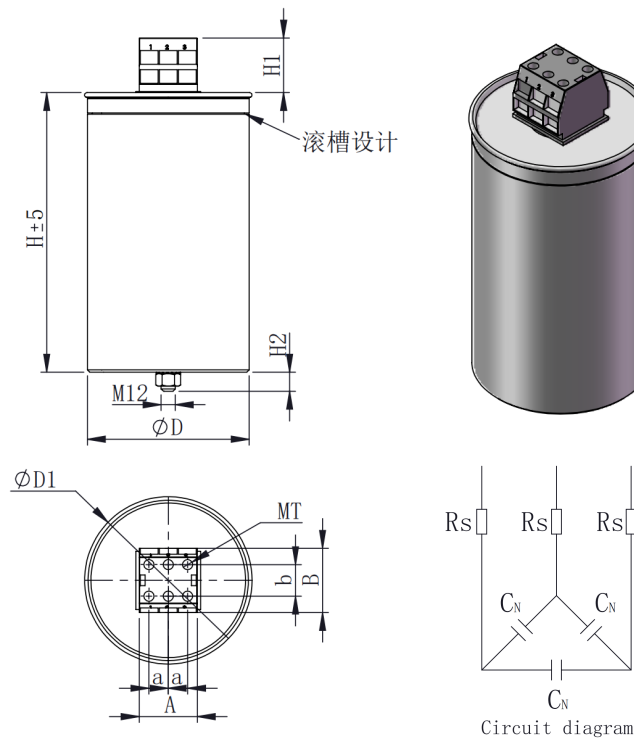

D±1	116	136
a±0.5	15	16.5
b±0.5	19.4	25
A±1	43.5	49
B±1	44.5	54.5
H1±2	35	45
H2±1	16	18
MT	M5	M6

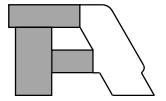

螺栓式设计(Bolt type design)

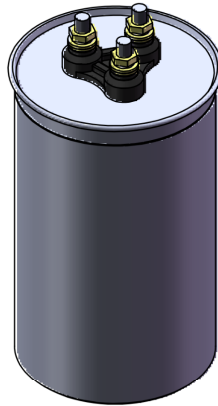
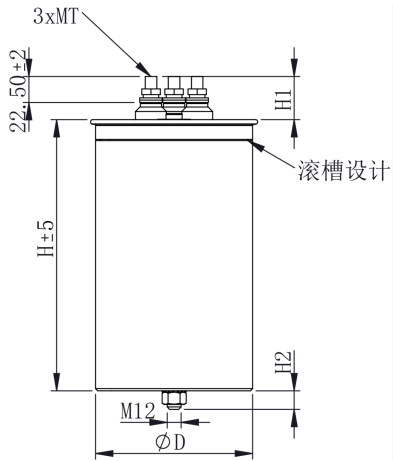

D±1	116	136
H1±1	38	38
H2±2	16	18
P±1	40	40
MT	M8	M8

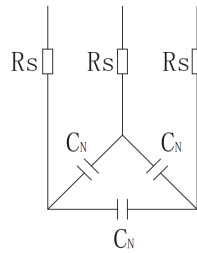
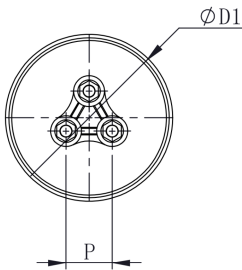

Circuit diagram

焊片式设计(Tab type design)

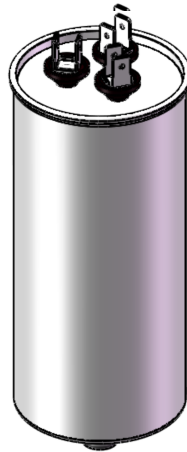
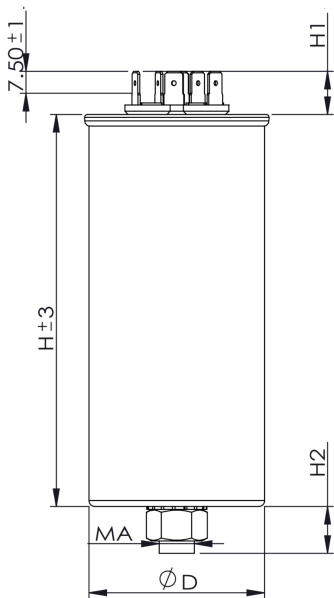

D±1	45	55	60
H1±1	12	12	12
H2±1	10	12	16
P±1.5	18	20	20
MA	M8	M10	M12

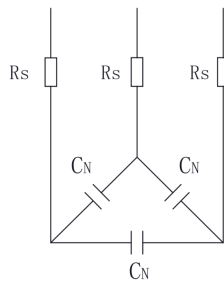
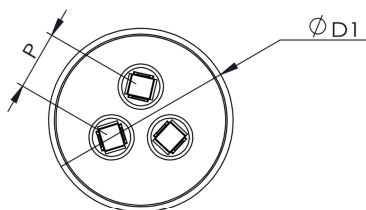

Circuit diagram

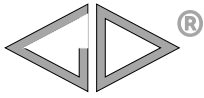

C67



■ 特点

- 金属化聚丙烯膜设计，自愈性优良
- 防爆设计，过压力保护更安全
- 结构多样化，有帽式、螺栓式、焊片式
- 适用于三相功率因数校正、LCL 滤波，广泛用于风电、光伏等场合

■ Features

- Metallized polypropylene film design, excellent self-healing property
- Anti-explosion design, overpressure tear-off fuse more safety
- Structural diversity, include cap type design, bolt type design and tab type design
- Suitable for power factor correction and LCL filter, widely used in wind power, photovoltaic and other occasions

■ 安全认证 Safety Approval

● 	TUV Rheinland (德国)	EN 61071:2017, EN 61881-1:2011, U_{rms} : 230Vac ~1 500Vac, U_N : 330Vac ~2 120Vac $3 \times 8\mu F \sim 3 \times 330\mu F$, -40°C/70°C 证书号(Certificate No.): R 50269769
● 	UL/CUL (美国/加拿大)	UL 810, max. 850Vac, 50Hz/60Hz, "Protected", 10 000AFC, max.90°C CSA C22.2.No190, max.660Vac, 50Hz/60Hz, 证书号(File No.): E232771, CCN: CYWT2/8

■ 技术要求 Specifications

引用标准 Reference standard	GB/T 17702 (IEC 61071) Optional: GB/T 12747(IEC 60831)
额定均方根电压 Rated RMS voltage (U_{rms})	230Vac~850Vac(可根据客户要求定制 $U_{rms} \leq 1 300Vac$ 的设计) (The design of $U_{rms} \leq 1 300Vac$ can be customized according to customer requirements)
额定频率 Rated frequency (f_N)	50Hz/60Hz
额定电容量 Rated capacitance (C_N)	$3 \times 8\mu F \sim 3 \times 330\mu F$
电容量偏差 Capacitance tolerance	$\pm 5\%$ (J), $\pm 10\%$ (K), $-5\% \sim +10\%$ (6)
电容内部连接方式 Capacitor internal connection	三角形接法 Delta connection (Δ)
极间耐电压 Test voltage between terminals (U_{T-T})	$2.15U_{rms}$ 或 $1.5U_N$ (50Hz/60Hz), 10s
极壳耐电压 Test voltage between terminals to case (U_{T-C})	4 000Vac(50Hz/60Hz), 10s
绝缘电阻 Insulation resistance ($IR \times C_N$)	$\geq 10 000s$ (20°C, 500V, 1min)
介质损耗角正切 Dielectric dissipation factor ($\tan\delta_d$)	2×10^{-4}
气候类别 Climatic category	40/70/56
可运行温度范围 (热点温度) Operating temperature range (θ_{hs})	-40°C~85°C(建议使用过程中, 保证 $\theta_{hs} \leq 70^\circ C$, 否则会影响寿命) (It is suggested that θ_{hs} should be guaranteed to be less than 70°C in the use process, otherwise the lifetime will be affected)
贮存温度范围 Storage temperature range (θ_s)	-40°C~85°C(若 $\theta_s > 70^\circ C$, 会影响电容寿命) (If $\theta_s > 70^\circ C$, the lifetime will be affected)
预期寿命 Expected lifetime	$ \Delta C/C \leq 5\%$ after 100 000h @ $0.8U_{rms}$, $\theta_{hs} \leq 70^\circ C$
防爆装置 Explosion-proof device	过压力防护装置 Overpressure disconnecter
内部填充料 Internal stuffing	Oil (Non PCB)
冷却方式 Cooling	自然空气或强制制冷 Naturally air-cooled or force cooled
是否有放电电阻 Whether has the discharge resistor	可根据客户要求配置 Configured according to customer requirements

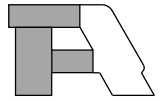

安装 Installation	位置 Position	端子朝上 Terminals upright
	引出端形式 Terminal form	帽式(插头螺栓 M5 或 M6) Cap type(Plug bolt M5 or M6)
		螺栓式 M8 Bolt type M8
	安装形式 Fixed style	焊片式 AMP250# 插片每边 2 个 Tab type Two AMP250# per side
电极最大扭矩 Max Torque of terminals		底部螺栓 M8 或 M10 或 M12 Bottom-bolt M8 or M10 or M12
最大安装扭矩 Max. Torque of Installation		2N·m(M5); 3N·m(M6); 6N·m(M8)
最高使用海拔 Max. altitude		5N·m(M8); 7N·m(M10); 10N·m(M12)
		2 000m: 电流不降额(No derating for current) 2 000m to 5 000m: 电流每 500m 按 3%降额 (Decreasing factor 3% per 500m for current)

■ 产品编码说明 Part number system

15 位产品代码如下:

The 15 digits part number is formed as follow:

1	2	3	4	5	6	7	8	9	10	11	12	13	14	15
C	6	7												

第 1~3 位	型号代码	Digit 1 to 3	Series code
	C67		C67
第 4~5 位	额定均方根电压	Digit 4 to 5	Rated RMS voltage
	P5=230Vac S1=440Vac T1=540Vac		P5=230Vac S1=440Vac T1=540Vac
	U2=690Vac V2=760Vac K2=800Vac		U2=690Vac V2=760Vac K2=800Vac
	W1=850Vac		W1=850Vac
第 6~8 位	标称容量	Digit 6 to 8	Rated capacitance value
	A to H & J 表示 0.1 to 0.9		A to H & J:0.1 to 0.9
	举例: 506=50×106pF= 50μF		for example: 506=50×106 pF= 50μF
	26E=26.5μF		26E=26.5μF
第 9 位	容量偏差	Digit 9	Capacitance tolerance
	J=±5%, K=±10%, 6=-5%~+10%		J=±5%, K=±10%, 6=-5%~+10%
第 10~15 位	内部特征码	Digit 10 to 15	Internal use

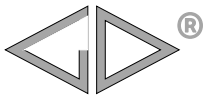

C67

■ 技术参数 Technical data

U _{rms} =230Vac U _N =325Vac											
C _N (μF)	D±1 (mm)	D1 _{max} (mm)	H (mm)	R _s (mΩ)	L _s (nH)	R _{th} (K/W)	I _{max} (A)	Î (kA)	Î _s (kA)	M (kg)	Part number
3×84	76	80	200	3×1.5	100	4.5	3×34	1.6	4.8	1.1	C67P5846-*****
3×105	76	80	230	3×1.6	120	4.0	3×36	1.5	4.5	1.2	C67P5004-*****
3×160	86	90	230	3×1.2	120	3.5	3×43	2.3	6.9	1.6	C67P5167-*****
3×250	116	121	200	3×0.8	110	3.1	3×53	3.0	9.0	2.4	C67P5257-*****
3×330	116	121	230	3×0.9	130	2.7	3×54	4.8	14.4	2.5	C67P5337-*****

U _{rms} =440Vac U _N =625Vac											
C _N (μF)	D±1 (mm)	D1 _{max} (mm)	H (mm)	R _s (mΩ)	L _s (nH)	R _{th} (K/W)	I _{max} (A)	Î (kA)	Î _s (kA)	M (kg)	Part number
3×13	76	80	140	3×1.8	100	6.2	3×22	0.8	2.4	0.9	C67S1136-*****
3×16.5	76	80	140	3×1.5	100	5.6	3×25	1.1	3.3	0.9	C67S116E-*****
3×26.5	76	80	200	3×2.3	100	4.4	3×25	0.8	2.4	1.2	C67S126E-*****
3×33	76	80	200	3×1.9	100	4.0	3×28	1.0	3.0	1.2	C67S1336-*****
3×50	86	90	200	3×1.4	110	3.4	3×34	1.5	4.5	1.4	C67S1506-*****
3×66	86	90	230	3×1.5	120	2.9	3×36	1.4	4.2	1.7	C67S1666-*****
3×83	106	111	200	3×1.1	110	3.1	3×40	2.4	7.2	2.4	C67S1836-*****
3×100	116	121	200	3×1.0	110	2.8	3×43	2.9	8.7	2.4	C67S1107-*****
3×133	136	142	200	3×0.9	120	2.5	3×46	3.9	11.7	3.3	C67S1A00-*****
3×154	136	142	200	3×0.8	120	2.3	3×48	4.0	12.0	3.3	C67S1021-*****
3×170	136	142	230	3×0.9	130	2.2	3×45	4.5	13.5	3.8	C67S1177-*****

U _{rms} =540Vac U _N =760Vac											
C _N (μF)	D±1 (mm)	D1 _{max} (mm)	H (mm)	R _s (mΩ)	L _s (nH)	R _{th} (K/W)	I _{max} (A)	Î (kA)	Î _s (kA)	M (kg)	Part number
3×19	76	80	170	3×1.0	110	5.1	3×32	1.0	3.0	1.0	C67T1196-*****
3×23	76	80	170	3×1.0	110	5.0	3×33	1.2	3.6	1.2	C67T1236-*****
3×39	86	90	200	3×0.9	110	4.0	3×39	1.4	4.2	1.7	C67T1396-*****
3×48	86	90	230	3×1.0	120	3.6	3×40	1.3	3.9	1.9	C67T1486-*****
3×96	136	142	230	3×0.8	130	2.8	3×47	2.6	7.8	3.8	C67T1966-*****

U _{rms} =690Vac U _N =980Vac											
C _N (μF)	D±1 (mm)	D1 _{max} (mm)	H (mm)	R _s (mΩ)	L _s (nH)	R _{th} (K/W)	I _{max} (A)	Î (kA)	Î _s (kA)	M (kg)	Part number
3×33.5	116	121	170	3×0.8	110	3.5	3×42	1.6	4.8	2.2	C67U233E-*****
3×38	116	121	200	3×0.8	110	3.5	3×40	1.3	3.9	2.4	C67U2386-*****

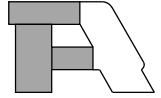

■ 技术参数 Technical data

U _{rms} =760Vac/850Vac [#] U _N =1 070Vac/1 200Vac											
C _N (μF)	D±1 (mm)	D1 _{max} (mm)	H (mm)	R _s (mΩ)	L _s (nH)	R _{th} (K/W)	I _{max} (A)	î (kA)	î _s (kA)	M (kg)	Part number
3×8	76	80	170	3×1.3	110	5.6	3×24	0.6	1.8	1.0	C67W1805-*****
3×10	86	90	170	3×1.1	110	5.2	3×27	0.7	2.1	1.0	C67W1106-*****
3×12	86	90	170	3×1.0	110	4.8	3×29	0.9	2.7	1.0	C67W1126-*****
3×17	106	111	170	3×0.9	110	4.3	3×34	1.1	3.3	1.7	C67W1176-*****
3×23	86	90	230	3×1.1	120	3.4	3×37	0.9	2.7	1.6	C67W1236-*****
3×28	106	111	230	3×1.0	130	3.3	3×38	1.0	3.0	2.2	C67W1286-*****
3×33	106	111	230	3×1.0	130	3.0	3×41	1.2	3.6	2.3	C67W1336-*****
3×38	116	121	230	3×0.9	130	2.9	3×42	1.4	4.2	2.8	C67W1386-*****
3×49	136	142	230	3×0.9	130	2.7	3×43	1.9	5.7	3.7	C67W1496-*****
3×55.8	136	142	230	3×0.8	130	2.5	3×45	2.2	6.6	3.8	C67W155H-*****

备注 Note: 1. “-”表示容量偏差。 “-”=capacitance tolerance code.

2. “*****”表示内部特征码, 请联系技术工程师确认完整代码。

“*****” = Internal use, please contact the technical engineer to confirm the complete code.

3. “#”当额定均方根电压为 760Vac 时, 第 4~5 位是 V2。

“#” when the rated RMS voltage is 760Vac, the digit 4~5 is V2.

4. “R_{th}”是指在自然冷却条件下, 电容器热点到环境的热阻。

“R_{th}” = R_{th} between hotspot and ambient on natural cooling condition.

5. “I_{max}”为通过电容器接线端子的最大电流, 表格中数值是基于温升不超过 30°C 计算所得, 其值必须小于端子所能承受的载流能力; 建议使用过程中电容器的最热点温度不超过 70°C, 必要时采取强制冷却措施。

“I_{max}” = The maximum current passing through the terminal of the capacitor. The value in the table is calculated based on the temperature rise not exceeding 30°C, and its value must be less than the current carrying capacity of the terminal. Recommend the most hot spot temperature does not exceed 70°C, forced cooling measures when necessary.

6. 如需星型接法、螺栓式(U_{rms}≤600Vac)设计产品, 请联系技术工程师。

If need star connection, bolts, tabs(U_{rms}≤600Vac) design, please contact our technical engineer.

7. 直径 116 和 136 的新设计均会采用滚槽设计。

The new designs with diameters 116 and 136 will adopt the channeling design.

■ 安装空间要求(以帽式设计为例) Installation space requirements (Take cap type design as an example)

电容要安装在阴凉、通风良好的位置, 且其周围不能有热辐射的物体, 如滤波电路电抗器、太阳直射。

The capacitor is to be installed at a cool and well-ventilated place, and must not be installed within the range of heat radiating objects, e.g. filter circuit reactors, direct sun radiation.

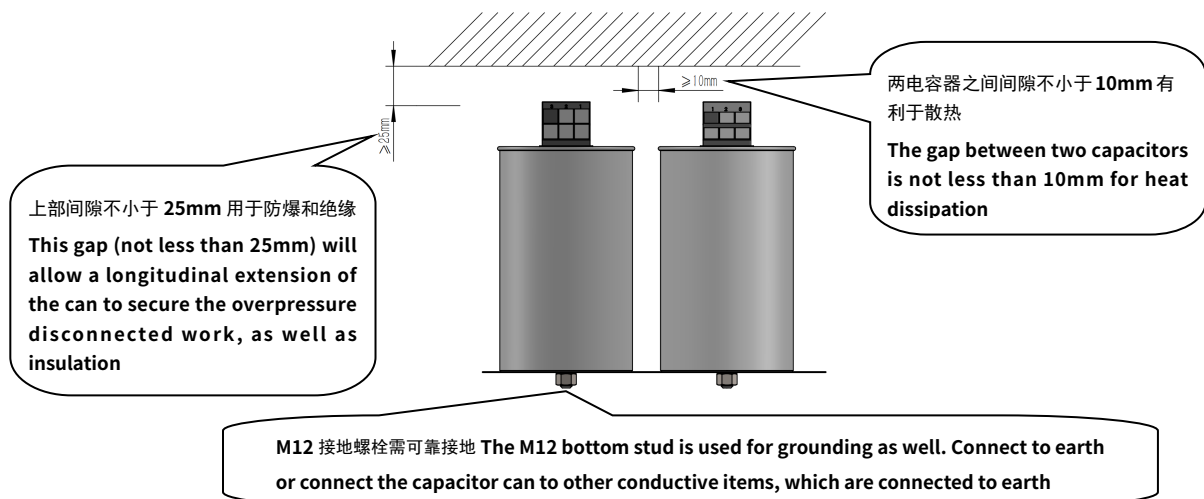

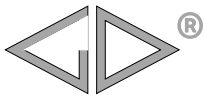

C67

电容主要是通过底部螺栓安装固定，若需要其它安装固定方式，请联系我司技术人员确认。

The capacitor is mainly installed by bolts at the bottom. If you need other installation methods, please contact our technical staff to check.

电容的过压力防护装置需要通过盖面鼓起动作，所以盖面到引出端顶部间不能安装影响防爆动作的其它配件，装置动作前后如下图所示。

The overpressure disconnecter of the capacitor is triggered by the cover bulge, so no other components can be installed between the cover and the top of the terminal end that affect the overpressure disconnecter action. Before and after the action of the overpressure disconnecter is shown in the figure below.

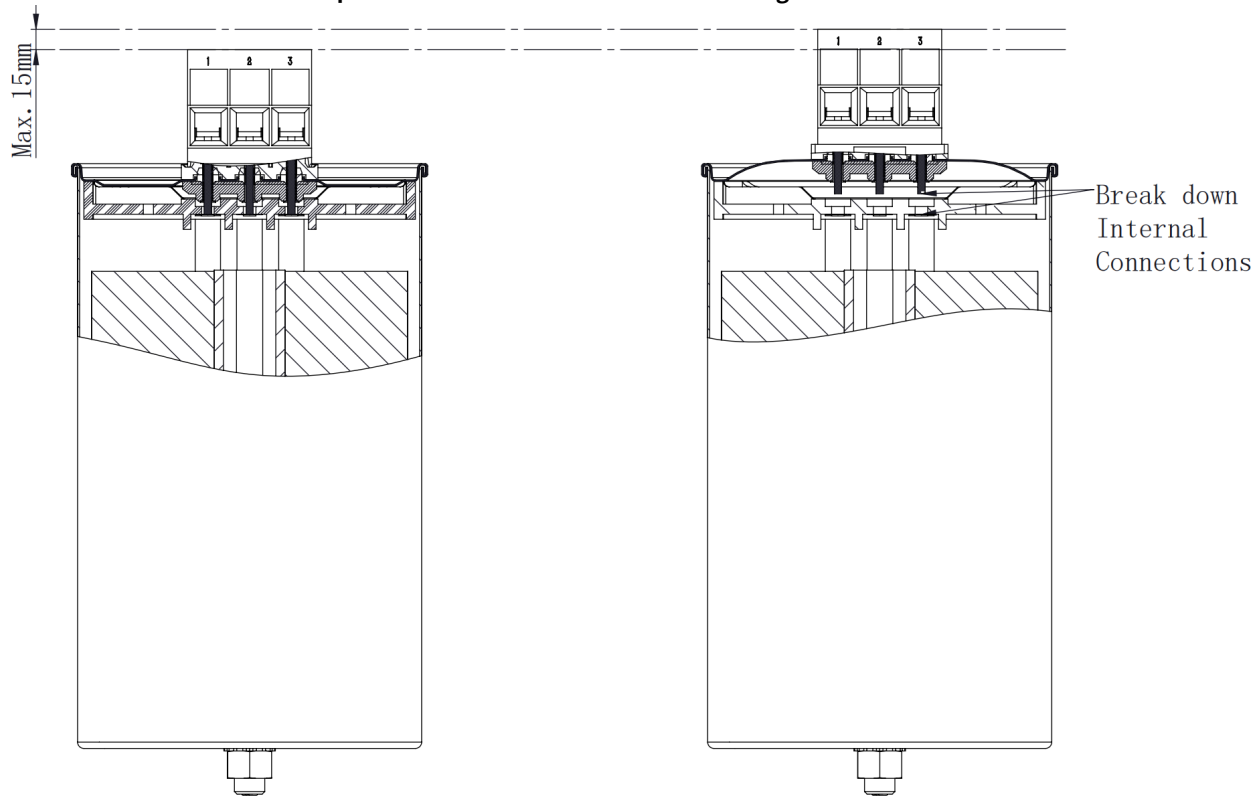

电容必须要垂直安装，且引出端子朝上。

The capacitor must be mounted vertically with the terminal is upward.

■ 连接电缆(以帽式设计为例) Connection of the supply cable(Take cap type design as an example)

产品本体（参考外形图的 $\phi D \times H$ ）上部必须保持足够的空间（参考安装空间要求），该空间内不能安装其它组件。

Keep enough space (refer to the outline drawing $\phi D \times H$) on the top of the capacitors (refer to installation space requirements) and no other components can be installed in this space.

连接电缆应使用软性电线并保持松弛，不要用硬芯电缆，若使用母排等连接方式，请联系我司技术人员确认。

The connection cable shall be of flexible type and keep slack, do not use hard core cable. If using busbar connection or other methods, please contact our technical staff to check.

对于帽式设计，可安装的最大引线截面积为 $16\text{mm}^2(\text{M5})/25\text{mm}^2(\text{M6})$ ，可根据实际电流值来选择合适的电缆。

For the cap type design, maximum cable cross section is $16\text{mm}^2(\text{M5})/25\text{mm}^2(\text{M6})$, according to actual result to choose the appropriate cable.

对于螺栓式设计，根据实际电流值来选择合适的电缆。

For the bolt type design, according to actual result to choose the appropriate cable.

以帽式设计为例，对于多个电容器并联，每个电容器采用直接连接到母线上方式，若有其它连接方式请联系我们。

Take cap type design as an example, for capacitors connected in parallel, each capacitor should use independent lead wires, if you have any other connection way please contact us.

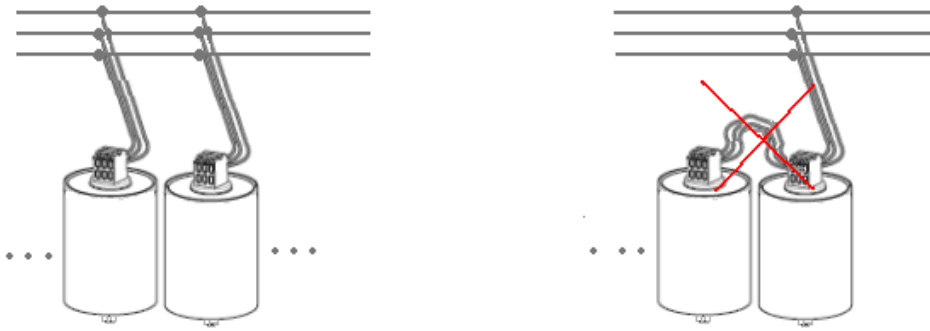
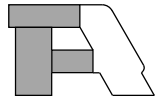

■ 安装注意事项 Installation cautions

操作前注意电容器必须充分放电。

Discharge the capacitor completely before operation.

注意端子最大可承受电流，端子总电流不得超出规定的最大值：

Pay attention to the Max. Current on the terminals, the total current on terminals must not go beyond the Max. current by specified:

● M8 引出螺栓最大电流为 80A。

The maximum current of the M8 lead bolt is 80A.

● M6 插头螺栓的引出端子最大电流为 60A。

The maximum current of M6 plug bolt is 60A.

● M5 插头螺栓的引出端子最大电流为 45A。

The maximum current of M5 plug bolt is 45A.

对于帽式设计，安装引出端子推荐使用一字螺丝刀，刀腿的直径小于防护盖孔以方便插入防护盖上的孔。

For the cap type design, recommend to using a slotted screwdriver to install the terminals.

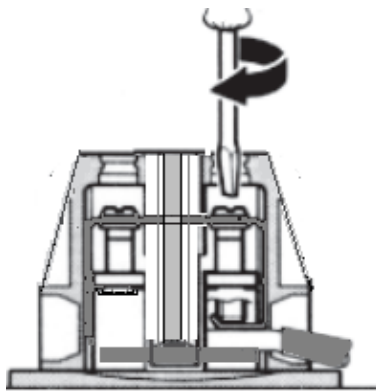

以帽式设计为例，电容器均只能作为一个独立的分支，不能在电容器的一端连接负载（放电电阻除外）。

Take cap type design as an example, each capacitor is only used as an independent subfield, and not connected the load in the terminals(Except discharge resistors).

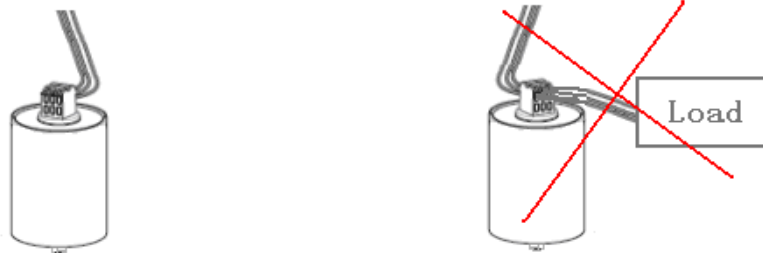

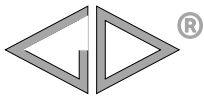

C67

■ 放电电阻连接 Connection of the discharge resistors

当用户有需求时，应提供将每一电容器单元或电容器组在 10min 之内从工作电压放电到 75V 或更低电压的装置。

When required by the user, each capacitor unit or bank shall be provided with means for discharging each unit in 10 min to 75 V or less, from a working voltage U_N .

放电电阻用于对电容器进行放电以保护人免受电击的危险，同时也在自动 PFC 装置内电容器进行切换时放电。

Discharge resistors are required for discharging capacitor for protection of human being (Electric shock risk), and for re-switching capacitors in automatic PFC equipment (Phase opposition).

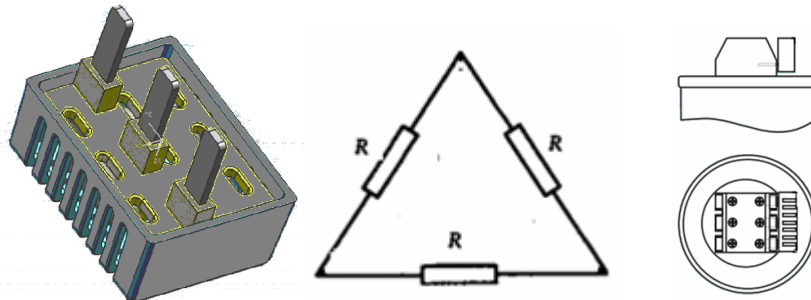

C67 帽式设计电容器系列有可选配的放电电阻，其配套的放电电阻能满足在 3min 内使电容器放电到 75V 或更低电压，放电电阻值的计算可以按如下公式：

Capacitors of the C67 series (cap type design) are fitted with discharge resistors for a discharge <75V within <180s, the resistors to be used can be calculated with the following formula:

$$R \leq \frac{T}{k \times C \times I_n \frac{U_N \times \sqrt{2}}{U}}$$

T: 放电时间 Discharge time

C: 每一相的容量 Capacitance of one phase

U_w : 实际工作电压 Operating voltage

U: 最大允许的残留电压

Maximum permissible voltage after discharging

k: 系数，内部使用 Δ 接法， $k=1$ ；内部使用 Y 接法， $k=1/3$ 。

Coefficient, if delta connection, $k=1$; if star connection, $k=1/3$.

■ 环境温度 Ambient temperature

建议电容使用环境温度 $\leq 55^\circ\text{C}$ ；当环境温度 $> 55^\circ\text{C}$ 时，随环境温度升高，电容发热功率应逐渐下降(当环境温度达最高温度 85°C 时，电容发热功率为 0W)。电容环境温度的使用，可参照预期寿命和电流随环境温度降额曲线。

The capacitors' working ambient temperature that we recommend is 55°C (or lower). When the ambient temperature exceeds 55°C , with the ambient temperature rising, the active power of the capacitor should be gradually decreased (When it gets to the highest temperature (85°C), the active power of the capacitor should be decreased to 0 Watt). If you want to know more details about the operating temperature of capacitors, please refers to the expected lifetime of capacitors and the current derating curve with ambient temperature.

电流随环境温度降额曲线

Current derating curve with ambient temperature

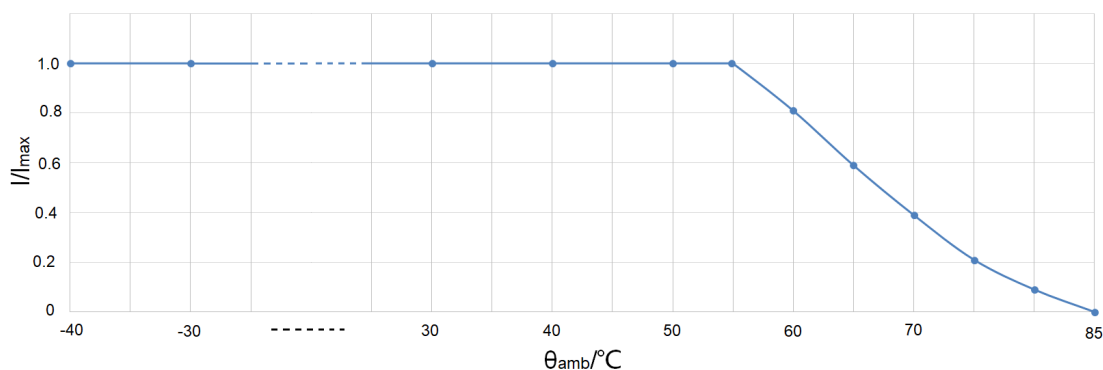

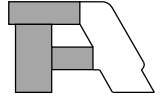

■ 冲击电流限制 Inrush current limitation

当电容器接入电路或设备切换时可能会出现高幅值和高频率的暂态过电流，暂态过电流可能是额定电流数十倍或更大的冲击电流，但要保证电容器不在电流超过 I_{\max} （最大电流）、 \hat{I} （最大峰值电流）和 \hat{I}_s （最大冲击电流）规定的最大参数值下运行。

When the capacitor is connected to the circuit or device switch may appear high amplitude and high frequency transient current, transient currents may be rated current several times or greater impact current, but to ensure that the capacitor is not current exceeds I_{\max} (maximum current), \hat{I} (maximum peak current), and \hat{I}_s (maximum impact current) the biggest parameter values regulations.

I_{\max} : 连续运行时的最大均方根电流。

I_{\max} : the maximum RMS current at continuous operation.

\hat{I} : 在连续运行中出现的最大重复峰值电流，通常持续时间为 ms 级。

\hat{I} : the maximum repeated peak current that occurs in continuous operation. Usually the duration is ms level.

\hat{I}_s : 由切换或系统中任何其它扰动所感应的非重复峰值电流，此电流只允许持续比基本周期短的时间和出现有限的次数，通常持续时间为 μ s 级且在生命周期内不超过 1 000 次。

\hat{I}_s : a non-repeating peak current induced by a switch or any other disturbance in the system that is allowed to last only a limited number of times shorter than the base period. Usually the duration is μ s level and it occurs not more than 1 000 times in a lifetime.

■ 谐波 Harmonics

谐波是由于一些非线性电器运行时造成的，这些载荷诸如现代电力电子中的转换器、电气传动、焊接机、备用电源等。

Harmonics result from the operation of electrical loads with non-linear voltage-current characteristics. They are caused by loads operated with modern power electronic, such as converters, electrical drives, welding machines and standby power supplies.

纹波由一系列频率为 50Hz 或 60Hz 倍数的正弦电流和电压组成。

Harmonics are sinusoidal voltages and currents with frequencies that are multiples of a 50Hz or 60Hz power supply frequency.

在使用过程中计算产品的温升以及核心热点温度是必要的，若使用过程中理论计算出的电容器热点超出了允许的最高范围，建议检查输入线的电流总谐波畸变率 THD_i ，并按以下要求执行：

It is necessary to calculate the temperature rise of the capacitors from hotspot to case during the using process. If the temperature rises of theoretical calculation of capacitors' hotspot beyond the maximum allowable range, we would propose to check the total harmonic current distortion (THD_i) of the input terminals, and according to the following requirements:

- 当 $I_N \geq 40A$ 时，建议 $THD_i \leq 50\%$ 。
When $I_N \geq 40A$, suggest $THD_i \leq 50\%$.
- 当 $40A > I_N \geq 35A$ 时，建议 $THD_i \leq 100\%$ 。
When $40A > I_N \geq 35A$, suggest $THD_i \leq 100\%$.
- 当 $35A > I_N \geq 25A$ 时，建议 $THD_i \leq 200\%$ 。
When $35A > I_N \geq 25A$, suggest $THD_i \leq 200\%$.
- 当 $25A > I_N \geq 15A$ 时，建议 $THD_i \leq 250\%$ 。
When $25A > I_N \geq 15A$, suggest $THD_i \leq 250\%$.
- 当 $I_N < 15A$ 时，关于 THD_i 的限定，请联系我司技术人员确认。
When $I_N < 15A$, please contact our technical staff to check the THD_i limit.

(注: I_N 是指额定均方根电压、额定容量条件下的基波电流。)

(Note: I_N is the fundamental current under rated RMS voltage and rated capacity.)

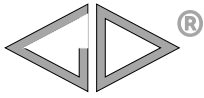

C67

$$THD_i = \frac{\sqrt{\sum_{n=1}^{\infty} I_n^2}}{I_0} \times 100(\%)$$

(THD_i: 电流总谐波畸变率; I₀: 实际工作的基波电流; I_n: 实际工作的谐波电流)

(THD_i: Total current harmonic distortion; I₀: Actual working fundamental current;

I_n: Actual working harmonic current)

■ 安全注意事项 Safety

电容器外壳保持良好和可靠接地。

Maintain good and effective earthing for enclosures of capacitors.

拆装电容器时要确保电容器已放电干净。

Handle capacitor to ensure capacitor has discharge clean.

遵循良好的工程规范。

Follow good engineering practices.

■ 过流/短路保护 Over current/short circuit protection

建议使用限流熔断器或塑壳断路器进行短路保护。短路保护的元件以及连接电缆需能长时间承受 1.5 倍电容器额定电流。

HRC-fuse or MCCB for short circuit protection is recommended to use. Short circuit protection equipment and connection cable should be selected so that the 1.5 times rated current of the capacitor can be managed permanently.

限流熔断器额定电流值应为正常电容电流的 1.6~1.8 倍。

HRC-fuse rating has to be 1.6 to 1.8 times nominal capacitor current.

使用热磁继电器为过载保护。

Use thermal magnetic overcurrent relays for overload protection.

■ 维护 Maintenance

检查连接线与端子螺丝是否打紧。

Check tightness of Connections/terminals periodically.

定期清理引出端子避免因灰尘或其它可导电的垃圾引起短路。

Clean the terminals periodically to avoid dust or other conductive garbage can cause a short-circuit.

检查短路保护保险丝。

Check short circuit protection fuses.

每半年使用电流钳表或其它在线测电流的工具测量电容器电流。

Every half a year use current clamp table or other on-line measuring tools of current measurement capacitor current.

检查放电电阻是否正常工作，可以通过电容器先上电后断开 3min 后测量电容器的电压是否降至 75V 以下来进行判断。

To check whether the discharge resistance is working normally, it can be judged by measuring whether the voltage of the capacitor drops to 75V after the capacitor is turned on first and disconnected for 3 minutes.

■ 安装与调试步骤 Installation & commissioning procedures

1、打开包装箱取出电容

Unpack Capacitor

取电容时请勿直接抓取端子

Do not touch capacitor terminals by hand directly while taking them

2、检查电容器外观（是否有机械损伤）

Check Physically

3、固定好电容器

Fixed capacitors



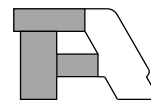

- 4、确保使用电容器场合的电压、频率、温度在电容器额定值以下
Ensure for correctness of supply voltage, frequency, temperature
- 5、连接好电容器
Connect Capacitor
- 6、打开电源开关
Switch on supply
- 7、检查主回路的电压与电流是否正常
Check main supply Voltage & current
- 8、电容器正常运行
Capacitor is commissioned

■ 预期寿命 Expected lifetime

电容器的应用中，有多种因素会影响到电容器的使用寿命，比如电压、温度、电流、电网谐波、湿度、光照或辐射以及其它一些未知的因素。预期寿命仅考虑电压、温度的关系，基于长期耐久性试验的合格结果，再通过预期寿命理论计算公式计算该电容在不同工况下的预期寿命。因此，预期寿命仅作为选型参考，而不代表电容器的实际使用寿命，也不代表质保要求。

For capacitors application, various factors will affect the expected lifetime of capacitors, such as voltage, temperature, current, network harmonics, humidity, lighting or radiation and other unknown factors. The lifetime only considers the effects of voltage and temperature. Based on the qualified results of long-term durability test, the lifetime curve of the capacitor under different working conditions is calculated by using the theoretical calculation formula of lifetime. Therefore, the lifetime is only used as a reference for selection, and does not represent the actual service life of the capacitor, nor does it represent the quality assurance requirements.