

|                        |                 |
|------------------------|-----------------|
| $V_{DS}$               | 1200 V          |
| $R_{DS,on}$            | 18.1 m $\Omega$ |
| $I_D (T_C=25^\circ C)$ | 93 A            |
| $T_{J,max}$            | 175 $^\circ C$  |

## 1200V SiC Full-Bridge Module

### Features

- High speed switching SiC MOSFETs
- Reliable body diode
- All parts tested to above 1350V
- Kelvin reference for stable operation
- Press fit terminal connections

### Benefits

- Low switching losses
- Low junction to case thermal resistance
- Very rugged and easy mounting
- Direct mounting to heatsink (isolated package)

### Applications

- Photovoltaic Inverter
- Battery charger
- Energy storage system
- High voltage DC to DC converter

### Package

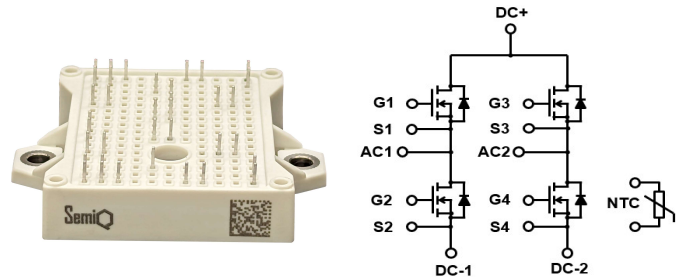

| Part #           | Package | Marking          |
|------------------|---------|------------------|
| GCMX020A120B3H1P | B3      | GCMX020A120B3H1P |



### Absolute Maximum Ratings, at $T_J=25^\circ C$ , unless otherwise specified

| Characteristics            | Symbol             | Conditions                                    | Values    | Unit       |
|----------------------------|--------------------|---|-----------|------------|
| Drain-Source Voltage       | $V_{rated}$        | $V_{GS}=0V, I_D=1\mu A$                       | 1200      | V          |
| Continuous Drain Current   | $I_{DS}$           | $T_C=25^\circ C, V_{GS}=20V, T_J=175^\circ C$ | 93        | A          |
|                            |                    | $T_C=65^\circ C, V_{GS}=20V, T_J=175^\circ C$ | 81        |            |
| Body Diode Drain Current   | $I_{SD}$           | $T_C=25^\circ C, V_{GS}=-5V, T_J=175^\circ C$ | 78        |            |
| Pulsed Drain Current       | $I_{DS,pulse}$     | $T_C=25^\circ C, V_{GS}=20V$                  | 250       |            |
| Gate Source Voltage        | $V_{GSmax}$        |   | -10/25    | V          |
|                            | $V_{GSop}$         | Recommended operational                       | -5/20     |            |
| Power Dissipation          | $P_{tot}$          | $T_C=25^\circ C, T_J=175^\circ C$             | 300       | W          |
| Junction Temperature       | $T_J$              | Continuous                                    | -40...175 | $^\circ C$ |
| Case & Storage Temperature | $T_C, T_{storage}$ | Continuous                                    | -40...150 | $^\circ C$ |

# 1200V SiC Full-Bridge Module

# GCMX020A120B3H1P

Static Electrical Characteristics, at  $T_J=25^\circ\text{C}$ , unless otherwise specified

| Characteristics                 | Symbol         | Conditions   | Values |      |       | Unit          |
|---------------------------------|----------------|--|--------|------|-------|---------------|
|                                 |                |  | min.   | typ. | max.  |               |
| Drain-Source Breakdown Voltage  | $BV_{DSS}$     | $V_{GS}=0V, I_D=1mA$   | 1200   | -    | -     | V             |
| Zero Gate Voltage Drain Current | $I_{DSS}$      | $V_{DS}=1200V, V_{GS}=0V$  | -      | 0.1  | 1     | $\mu\text{A}$ |
|                                 |                | $V_{DS}=1200V, V_{GS}=0V, T_J=150^\circ\text{C}$                                     | -      | 1    | 100   |               |
| Gate-Source Leakage Current     | $I_{GSS+}$     | $V_{GS}=20V, V_{DS}=0V$  | -      | 10   | 1000  | nA            |
|                                 | $I_{GSS-}$     | $V_{GS}=-5V, V_{DS}=0V$  | -      | -10  | -1000 |               |
| Gate Threshold Voltage          | $V_{GS(th)}$   | $V_{GS}=V_{DS}, I_D=20mA$  | 1.8    | 2.9  | 4     | V             |
|                                 |                | $V_{GS}=V_{DS}, I_D=20mA, T_J=150^\circ\text{C}$                                     | -      | 1.9  | -     |               |
| Drain-Source On-Resistance      | $R_{DS(on)}^*$ | $V_{GS}=20V, I_D=50A$  | -      | 18.1 | 28    | m $\Omega$    |
|                                 |                | $V_{GS}=20V, I_D=25A$  | -      | 17.3 | -     |               |
|                                 |                | $V_{GS}=20V, I_D=50A, T_J=150^\circ\text{C}$   | -      | 27.0 | -     |               |
| Transconductance                | $g_{fs}$       | $V_{DS}=20V, I_D=50A$  | -      | 23.3 | -     | S             |
|                                 |                | $V_{DS}=20V, I_D=50A, T_J=150^\circ\text{C}$   | -      | 25.4 | -     |               |
| Internal Gate Resistance        | $R_{G(int)}$   | f=1MHz, $V_{AC}=25mV$ , D-S Short, including internal 2.0 ohm series gate resistor** | -      | 3.1  | -     | $\Omega$      |

\* $R_{DS(on)}$  including package resistance

\*\*Internal series gate resistor limits maximum switching frequency defined by Figure 31

AC Electrical Characteristics, at  $T_J=25^\circ\text{C}$ , unless otherwise specified

| Characteristics              | Symbol          | Conditions  | Values |      |      | Unit          |
|------------------------------|-----------------|---|--------|------|------|---------------|
|                              |                 |   | min.   | typ. | max. |               |
| Input Capacitance            | $C_{ISS}$       | $V_{GS}=0V$   | -      | 6.7  | -    | nF            |
| Output Capacitance           | $C_{OSS}$       | $V_{DS}=800V$   | -      | 0.34 | -    |               |
| Reverse Transfer Capacitance | $C_{RSS}$       | f=200kHz  | -      | 0.02 | -    |               |
| Coss Stored Energy           | $E_{OSS}^{***}$ | $V_{ac}=25mV$   | -      | 128  | -    | $\mu\text{J}$ |
| Turn-On Switching Energy     | $E_{ON}$        | $T_J=25^\circ\text{C}$  | -      | 0.63 | -    | mJ            |
|                              |                 | $T_J=125^\circ\text{C}$   | -      | 0.82 | -    |               |
|                              |                 | $T_J=150^\circ\text{C}$   | -      | 0.88 | -    |               |
| Turn-Off Switching Energy    | $E_{OFF}$       | $T_J=25^\circ\text{C}$  | -      | 0.14 | -    |               |
|                              |                 | $T_J=125^\circ\text{C}$   | -      | 0.15 | -    |               |
|                              |                 | $T_J=150^\circ\text{C}$   | -      | 0.15 | -    |               |
| Turn-On Delay Time           | $t_{D(on)}$     | $V_{DD}=600V, I_{DS}=50A, R_{G(ext)}=3.3\Omega, V_{GS}=-5V/20V, L=273\mu\text{H}$ | -      | 26   | -    | ns            |
| Rise Time                    | $t_R$           |   | -      | 10   | -    |               |
| Turn-Off Delay Time          | $t_{D(off)}$    |   | -      | 46   | -    |               |
| Fall Time                    | $t_F$           |   | -      | 18   | -    |               |
| Total Gate Charge            | $Q_G$           | $V_{DD}=800V, I_{DS}=50A, V_{GS}=-5/20V$  | -      | 250  | -    | nC            |
| Gate to Source Charge        | $Q_{GS}$        |   | -      | 94   | -    |               |
| Gate to Drain Charge         | $Q_{GD}$        |   | -      | 38   | -    |               |

\*\*\* $E_{OSS}$  is calculated from  $C_{OSS}$  curve

# 1200V SiC Full-Bridge Module

# GCMX020A120B3H1P

Freewheeling Diode Characteristics, at  $T_J=25^\circ\text{C}$ , unless otherwise specified

| Characteristics               | Symbol    | Conditions  | Values |      |      | Unit          |
|-------------------------------|-----------|---|--------|------|------|---------------|
|                               |           |   | min.   | typ. | max. |               |
| Diode Forward Voltage         | $V_{SD}$  | $V_{GS}=-5\text{V}, I_S=50\text{A}$   | -      | 3.9  | -    | V             |
|                               |           | $V_{GS}=-5\text{V}, I_S=50\text{A}, T_J=150^\circ\text{C}$  | -      | 3.5  | -    |               |
| Reverse Recovery Time         | $t_{RR}$  | $T_J=25^\circ\text{C}$<br>$I_S=50\text{A},$<br>$V_R=600\text{V},$<br>$V_{GS}=-5\text{V},$<br>$di/dt=7.9\text{A/ns}$ | -      | 28   | -    | ns            |
| Reverse Recovery Charge       | $Q_{RR}$  |   | -      | 519  | -    | nC            |
| Peak Reverse Recovery Current | $I_{RRM}$ |   | -      | 60   | -    | A             |
| Reverse Recovery Energy       | $E_{RR}$  | $T_J=25^\circ\text{C}$  | -      | 0.13 | -    | $\mu\text{J}$ |
|                               |           | $T_J=125^\circ\text{C}$   | -      | 0.34 | -    |               |
|                               |           | $T_J=150^\circ\text{C}$<br>$R_{G(\text{ext})} = 3.3\Omega$  | -      | 0.42 | -    |               |

Thermal and Package Characteristics, at  $T_J=25^\circ\text{C}$ , unless otherwise specified

| Characteristics                         | Symbol     | Conditions   | Values |      |      | Unit               |
|---|------------|--|--------|------|------|--------------------|
|   |            |  | min.   | typ. | max. |                    |
| Thermal resistance, junction-case       | $R_{thJC}$ |  | -      | 0.45 | 0.50 | $^\circ\text{C/W}$ |
| Mounting torque                         | $M_d$      | M4-0.7 screws  | -      | 2.00 | 2.3  | N-m                |
| Press fit pin PCB end hole diameter     |            |  | 0.99   | -    | 1.09 | mm                 |
| Press fit pin PCB hole drill diameter   |            |  | 1.12   | 1.15 | -    | mm                 |
| Press fit pin PCB hole copper thickness |            |  | 25     | -    | 50   | $\mu\text{m}$      |
| Package weight                          | $W_t$      |  | -      | 40   | -    | g                  |
| Isolation voltage                       | $V_{ISOL}$ | $I_{ISOL} < 1\text{mA}, 50/60\text{ Hz}, 1\text{ min}$ | 2500   | -    | -    | V                  |

NTC Characteristics, at  $T_J=25^\circ\text{C}$ , unless otherwise specified

| Characteristics                         | Symbol          | Conditions                   | Values |      |      | Unit       |
|---|-----------------|------------------------------|--------|------|------|------------|
|   |                 |                              | min.   | typ. | max. |            |
| Rated resistance                        | $R_{NTC}$       | $T_{NTC} = 25^\circ\text{C}$ | -      | 5.0  | -    | k $\Omega$ |
| Resistance tolerance                    | $\Delta R/R$    |                              | -5     | -    | 5    | %          |
| Beta Value ( $T_2 = 50^\circ\text{C}$ ) | $\beta_{25/50}$ |                              | -      | 3380 | -    | k          |
| Beta Value ( $T_2 = 80^\circ\text{C}$ ) | $\beta_{25/80}$ |                              | -      | 3440 | -    | k          |
| Power dissipation                       | $P_{MAX}$       | $T_{NTC} = 25^\circ\text{C}$ | -      | -    | 50   | mW         |

## Typical Performance

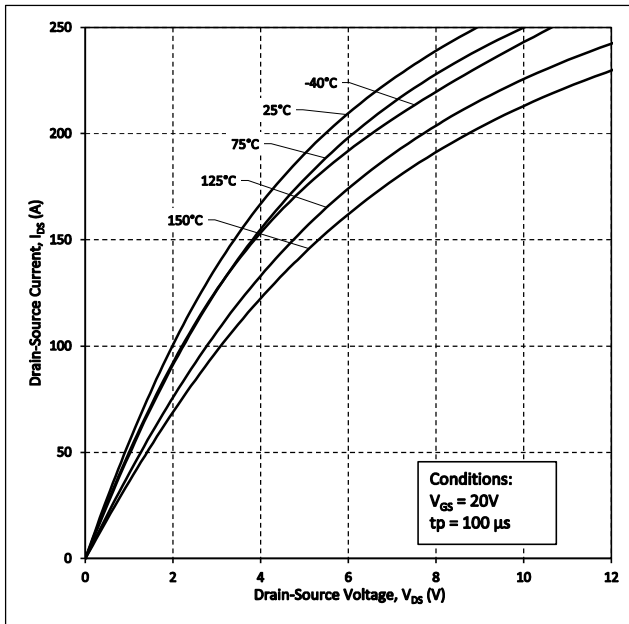

Figure 1. Output Characteristics for Various Temperatures

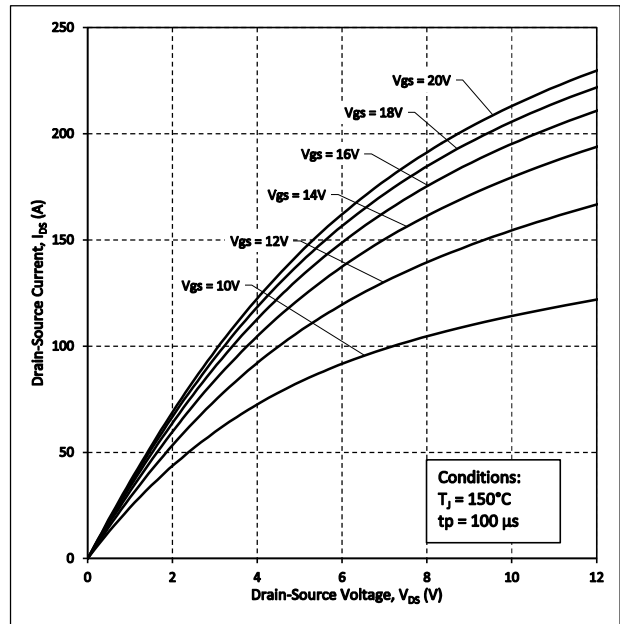

Figure 2. Output Characteristics  $T_J = 150^\circ C$

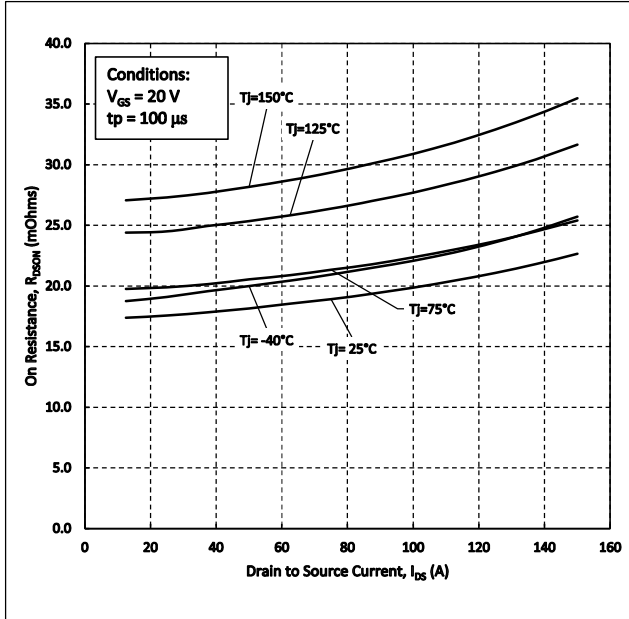

Figure 3. On-Resistance vs. Drain Current For Various Temperatures

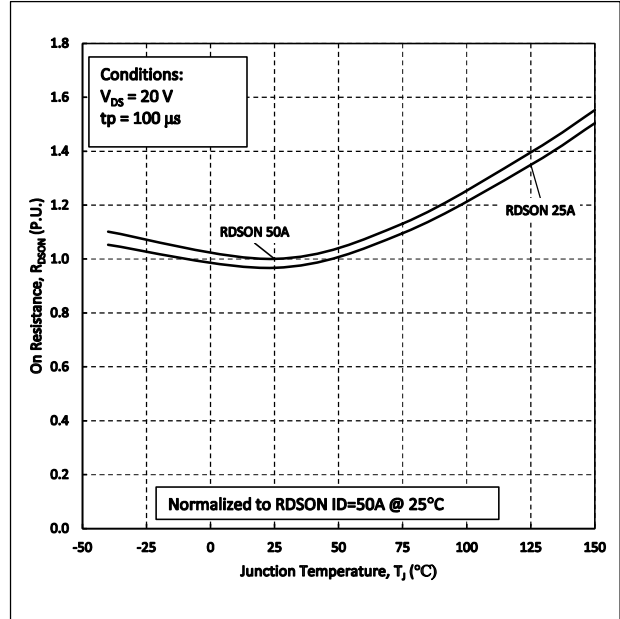

Figure 4. Normalized On-Resistance vs. Temperature

# 1200V SiC Full-Bridge Module

# GCMX020A120B3H1P

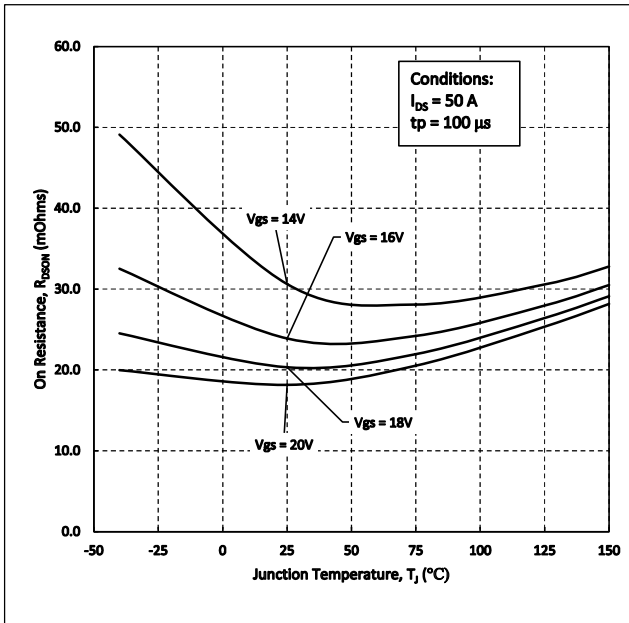

Figure 5. On-Resistance vs. Temperature For Various Gate Voltages

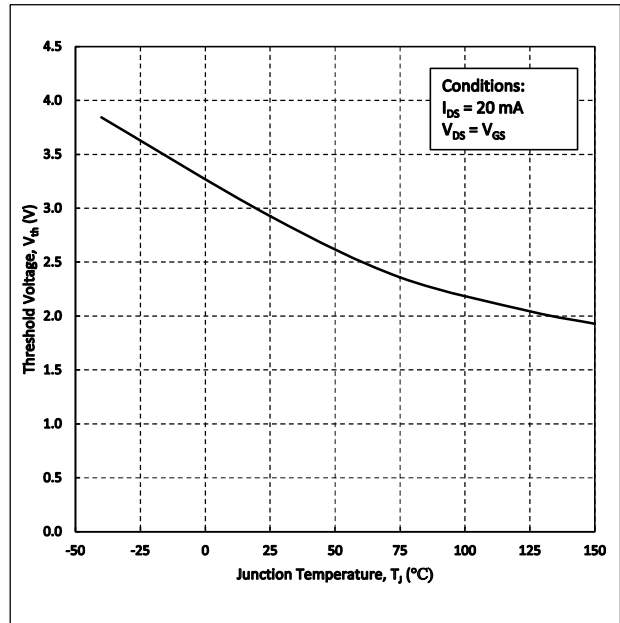

Figure 6. Threshold Voltage vs. Temperature

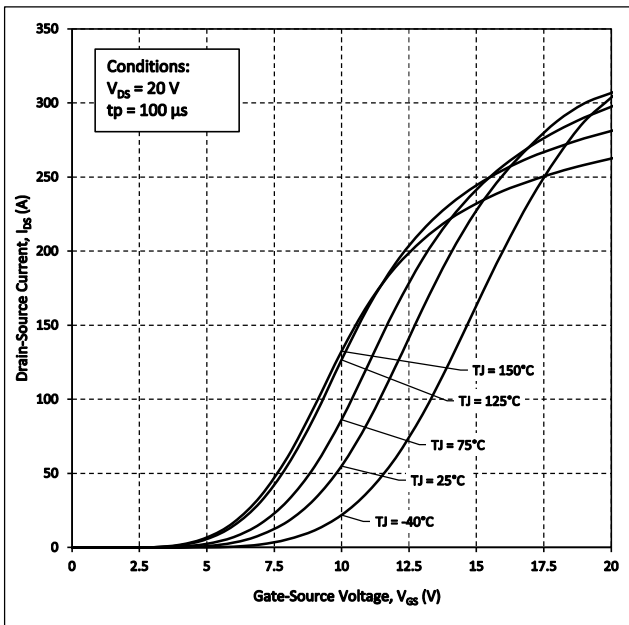

Figure 7. Transfer Characteristic for Various Junction Temperatures

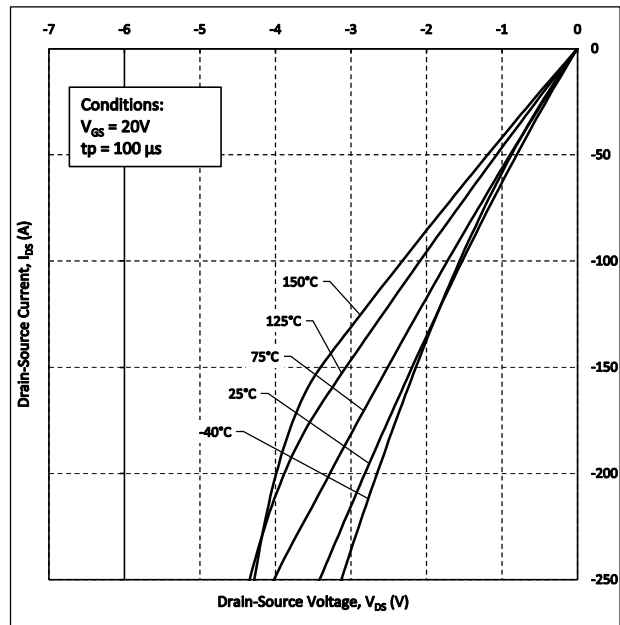

Figure 8. 3<sup>rd</sup> Quadrant Characteristics at  $V_{GS} = 20V$

# 1200V SiC Full-Bridge Module

# GCMX020A120B3H1P

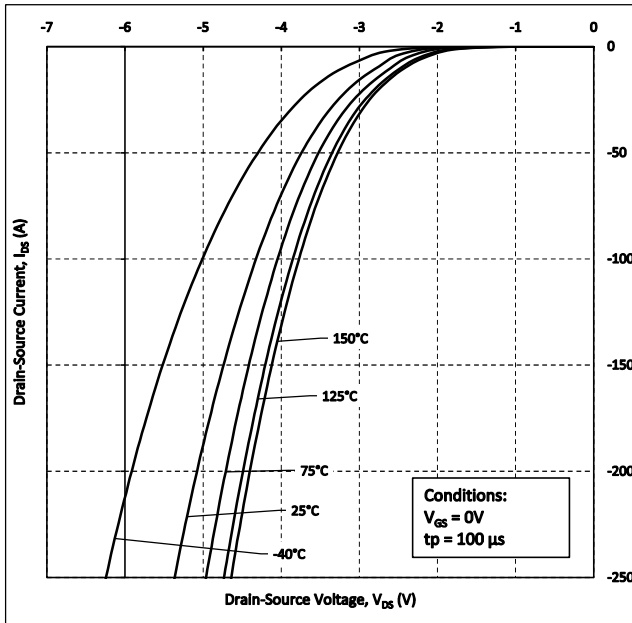

Figure 9. Body Diode Characteristics at  $V_{GS} = 0V$

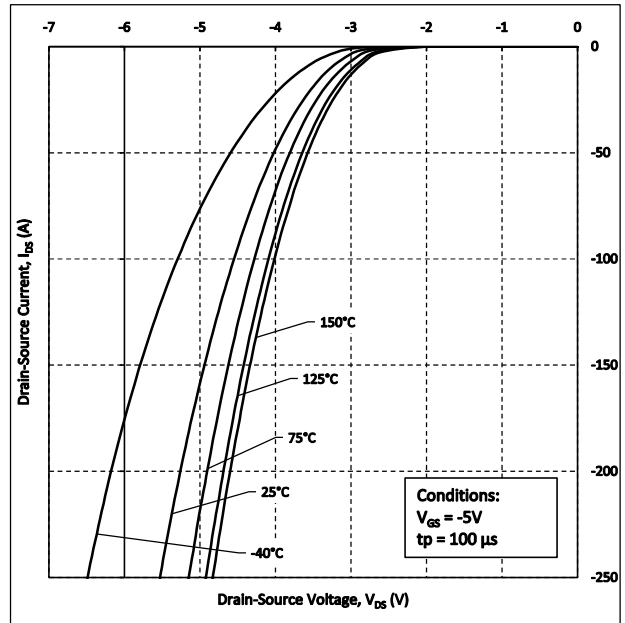

Figure 10. Body Diode Characteristics at  $V_{GS} = -5V$

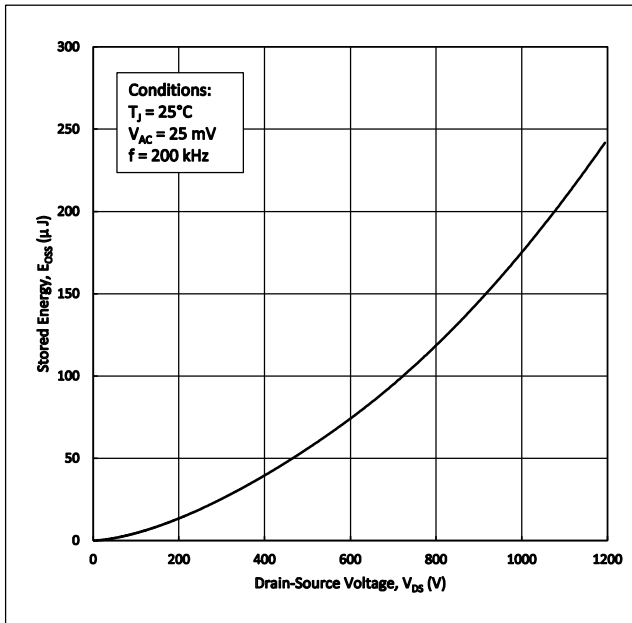

Figure 11. Output Capacitor Stored Energy

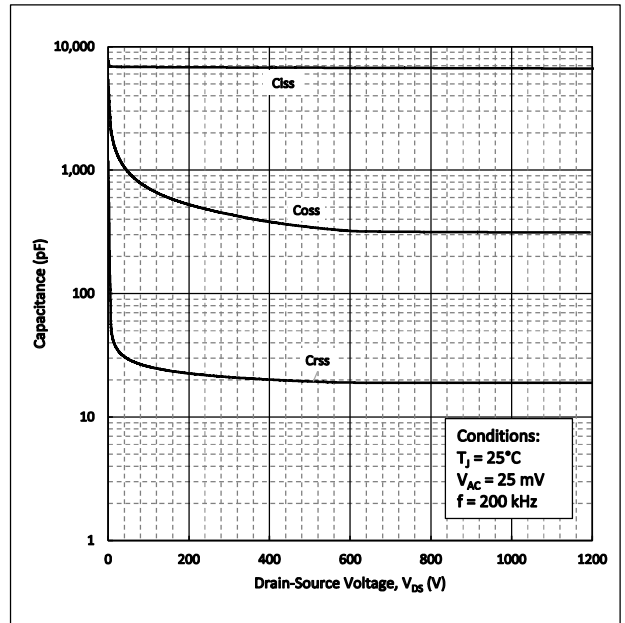

Figure 12. Capacitance vs. Drain-Source Voltage

# 1200V SiC Full-Bridge Module

# GCMX020A120B3H1P

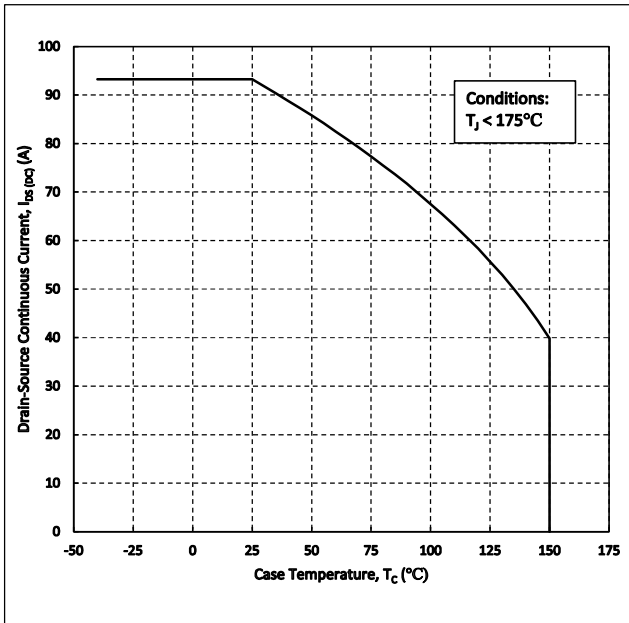

Figure 13. Continuous Drain Current Derating vs. Case Temperature

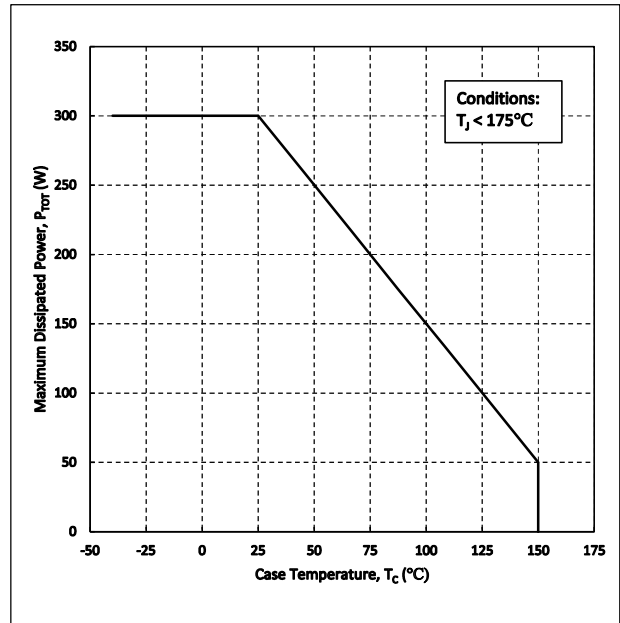

Figure 14. Maximum Power Dissipation Derating vs. Case Temperature

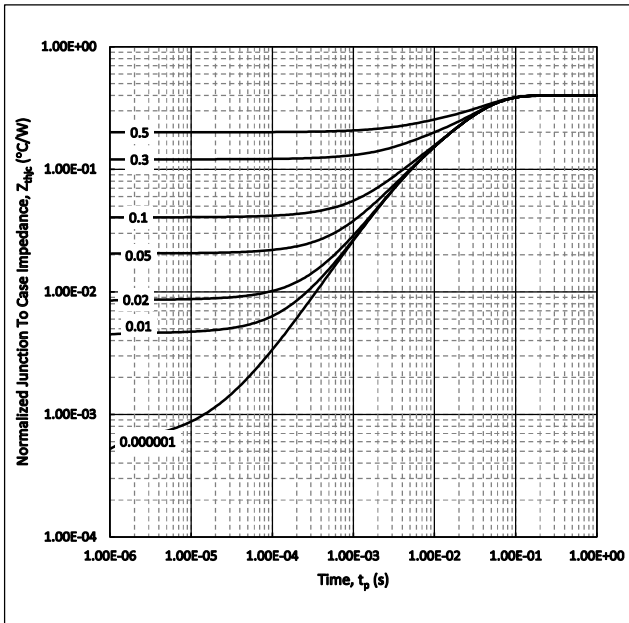

Figure 15. Transient Thermal impedance (Junction to Case)

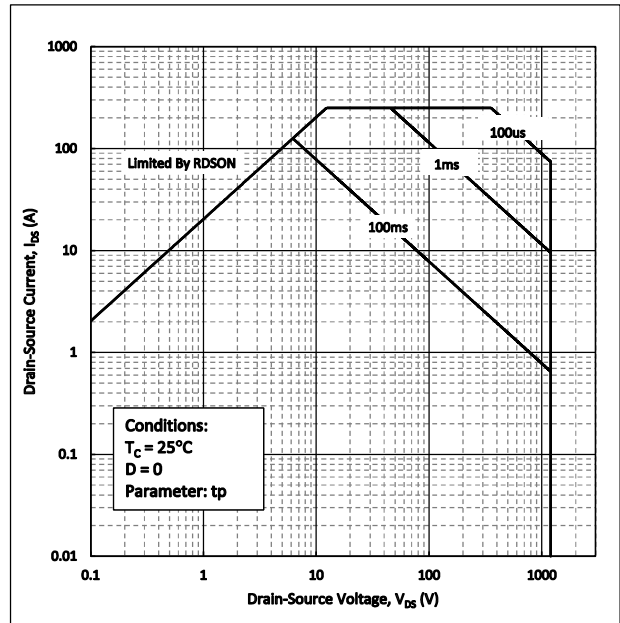

Figure 16. Safe Operating Area

# 1200V SiC Full-Bridge Module

# GCMX020A120B3H1P

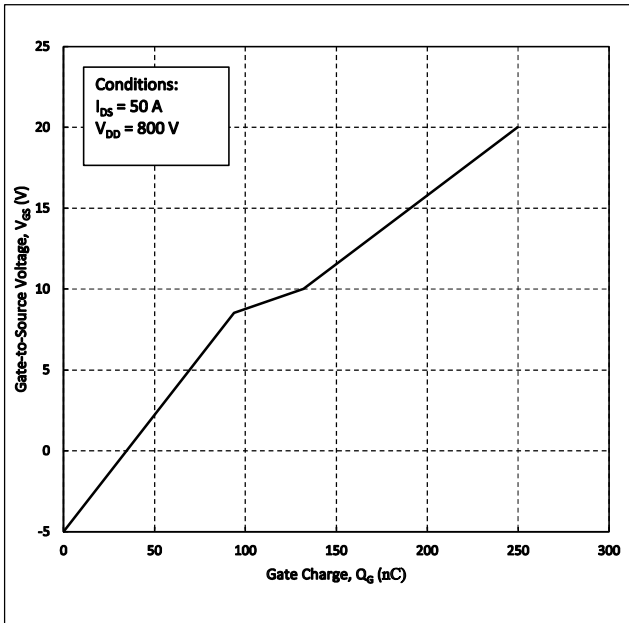

Figure 17. Gate Charge Characteristics

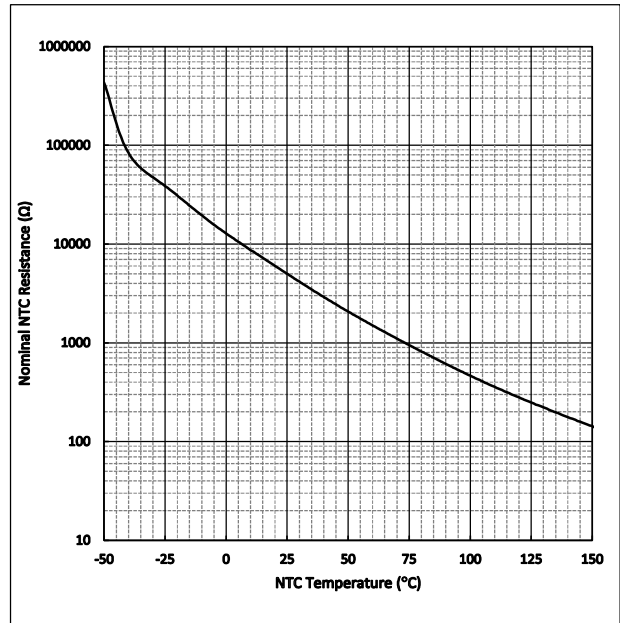

Figure 18. Nominal NTC Resistance vs. Temperature

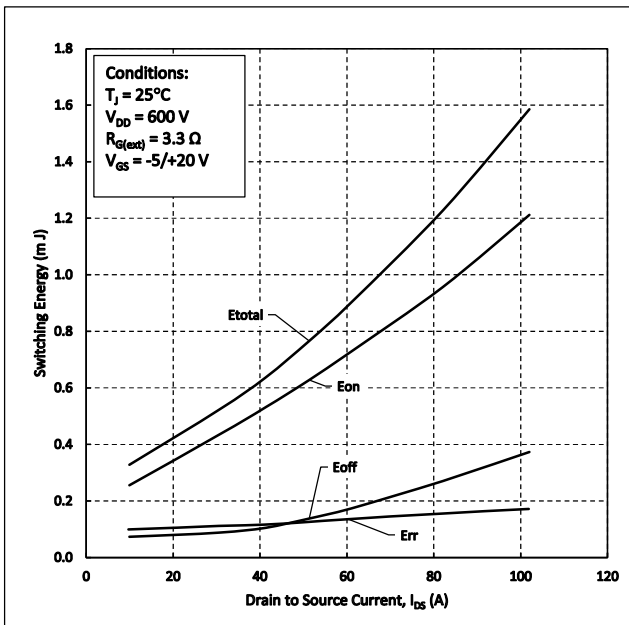

Figure 19. Clamped Inductive Switching Energy vs. Drain Current (600V)

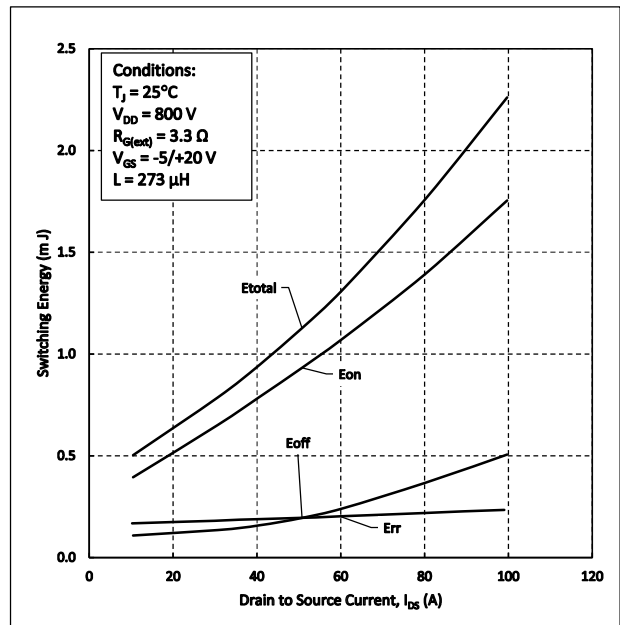

Figure 20. Clamped Inductive Switching Energy vs. Drain Current (800V)



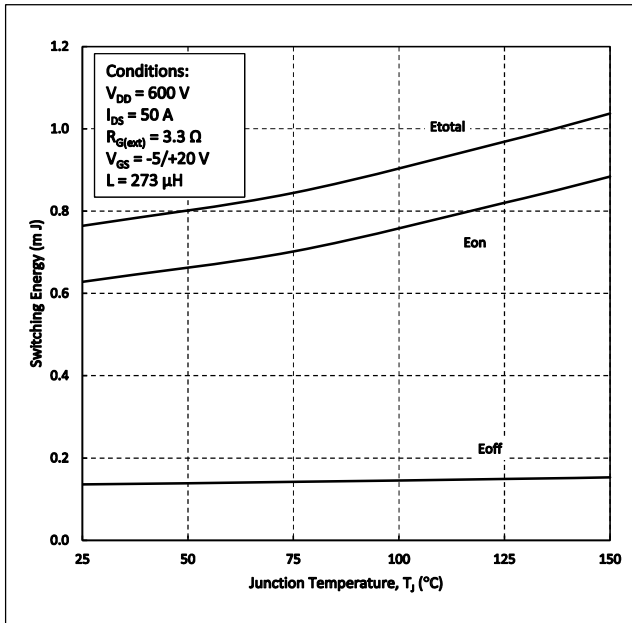

Figure 21. Clamped Inductive Switching Energy vs. Temperature

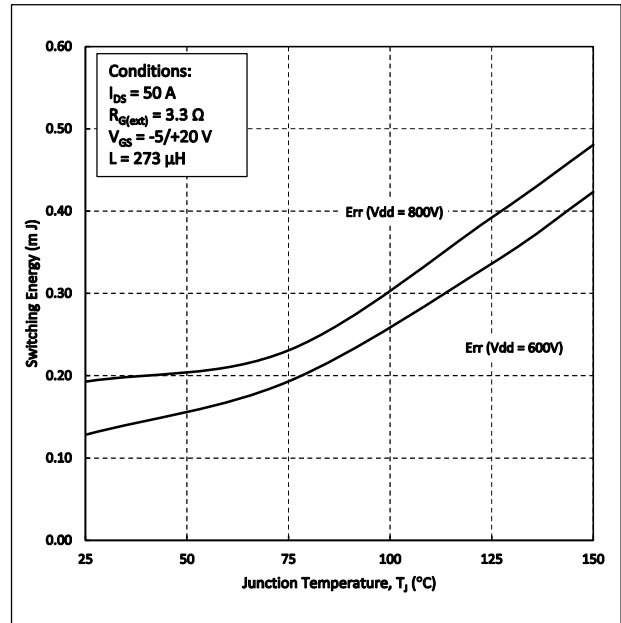

Figure 22. Reverse Recovery Energy vs. Temperature

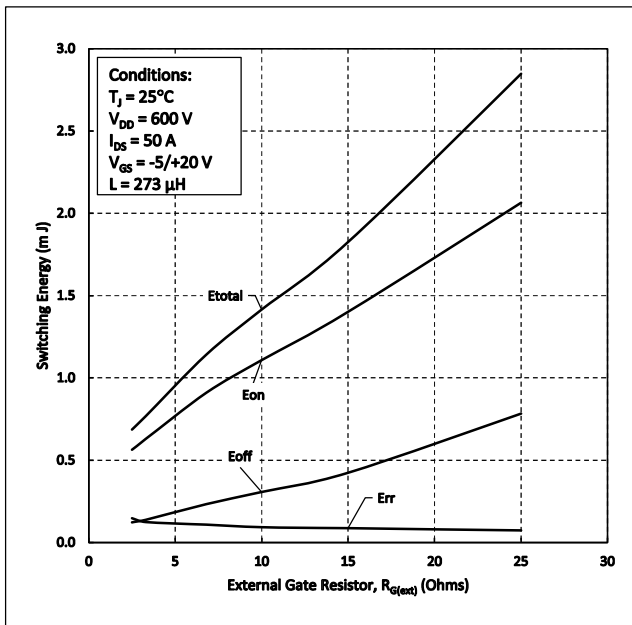

Figure 23. Clamped Inductive Switching Energy vs.  $R_{G(ext)}$

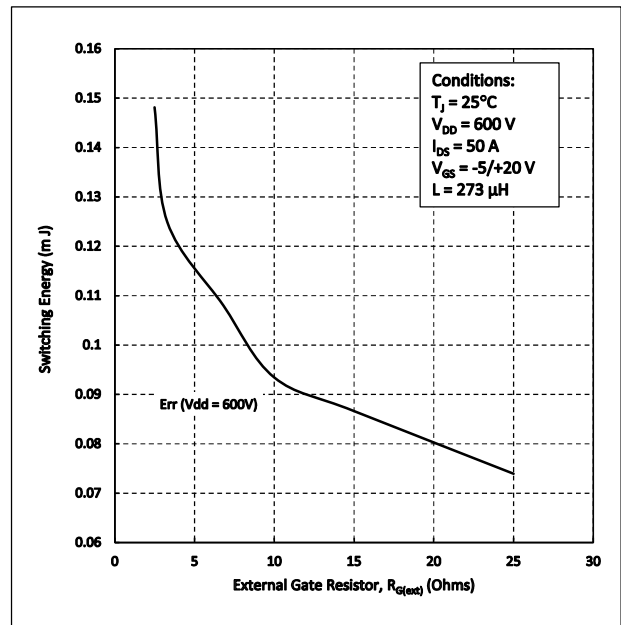

Figure 24. Reverse Recovery Energy vs.  $R_{G(ext)}$

# 1200V SiC Full-Bridge Module

# GCMX020A120B3H1P

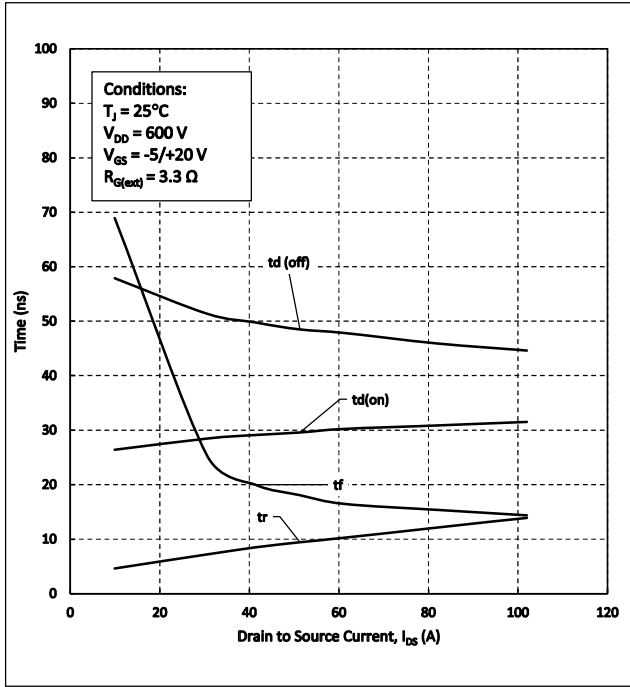

Figure 25. Switching Times vs. Drain Current

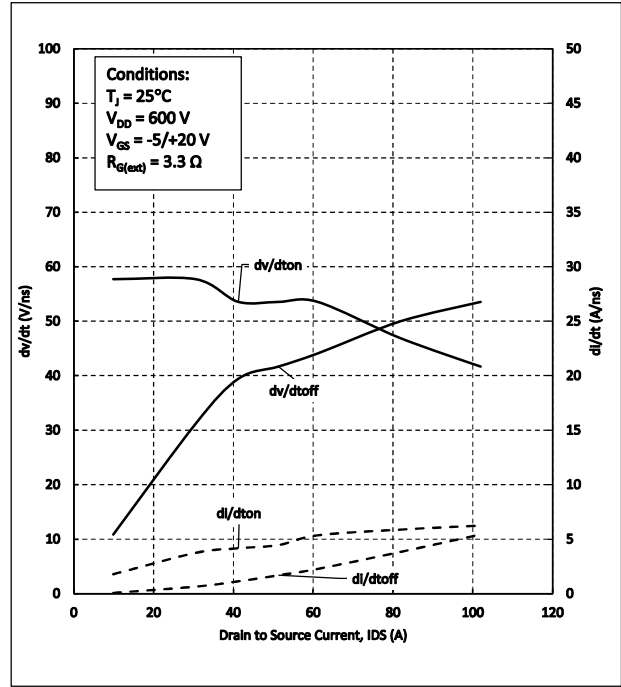

Figure 26.  $dv/dt$  and  $di/dt$  vs. Source Current

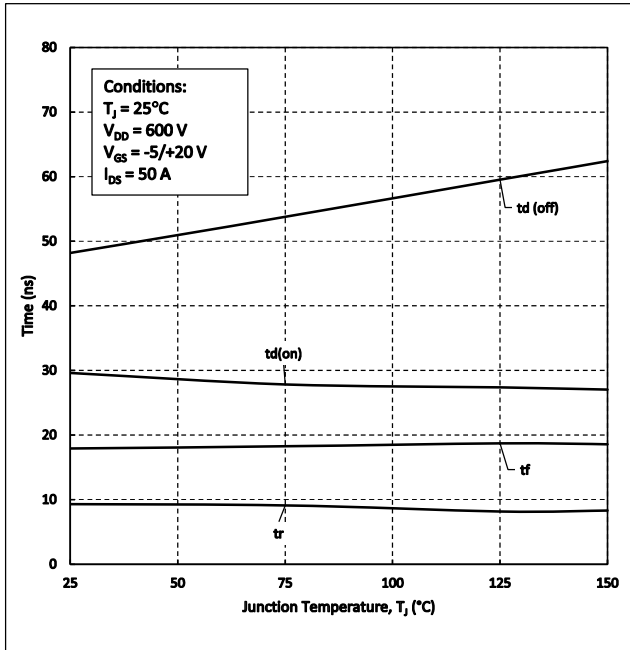

Figure 27. Switching Times vs. Temperature

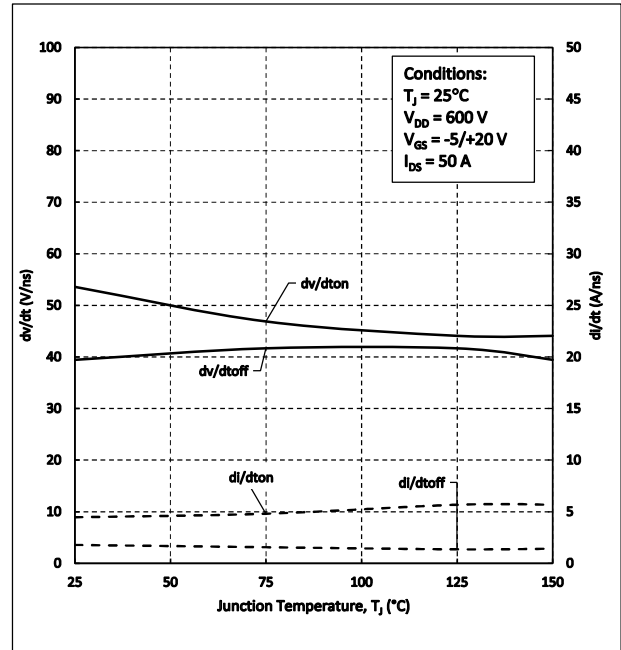

Figure 28.  $dv/dt$  and  $di/dt$  vs. Temperature

# 1200V SiC Full-Bridge Module

# GCMX020A120B3H1P

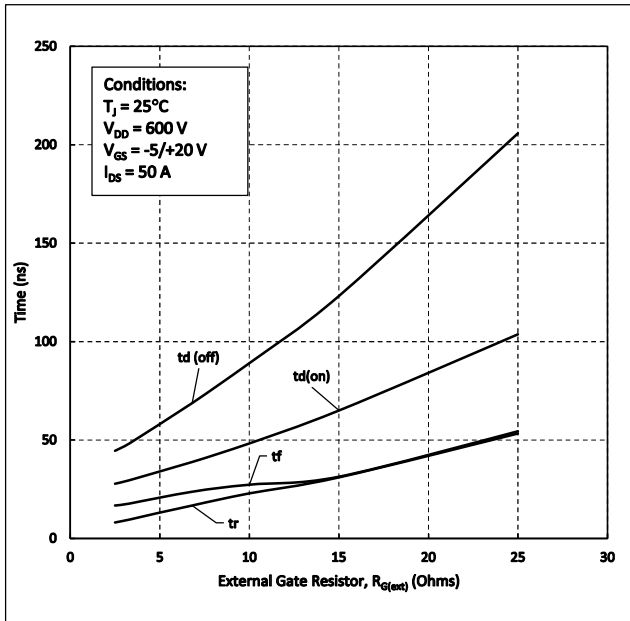

Figure 29. Switching Times vs.  $R_{G(ext)}$

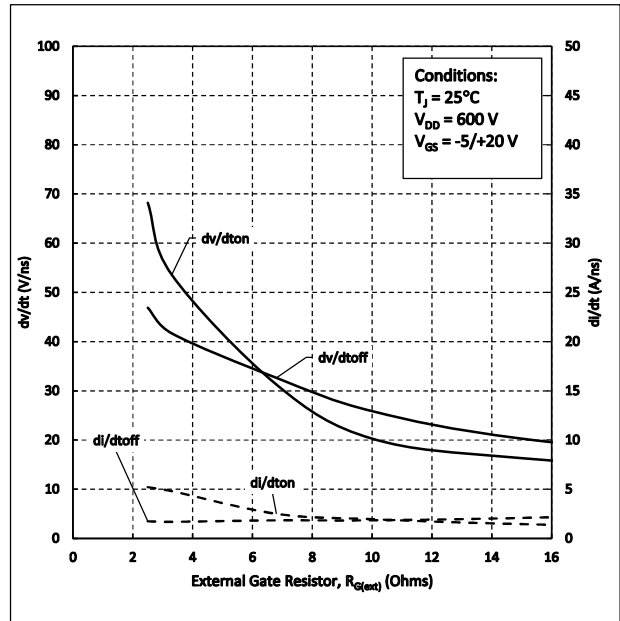

Figure 30.  $dv/dt$  and  $di/dt$  vs.  $R_{G(ext)}$

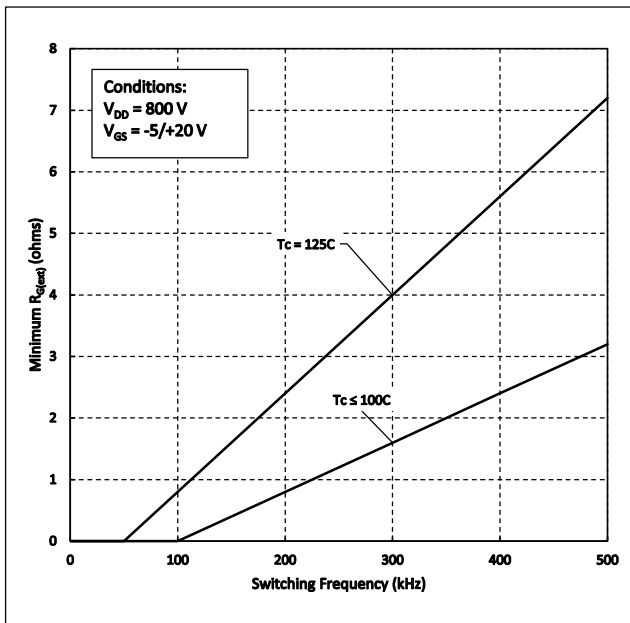

Figure 31. Frequency vs. Minimum  $R_{G(ext)}$

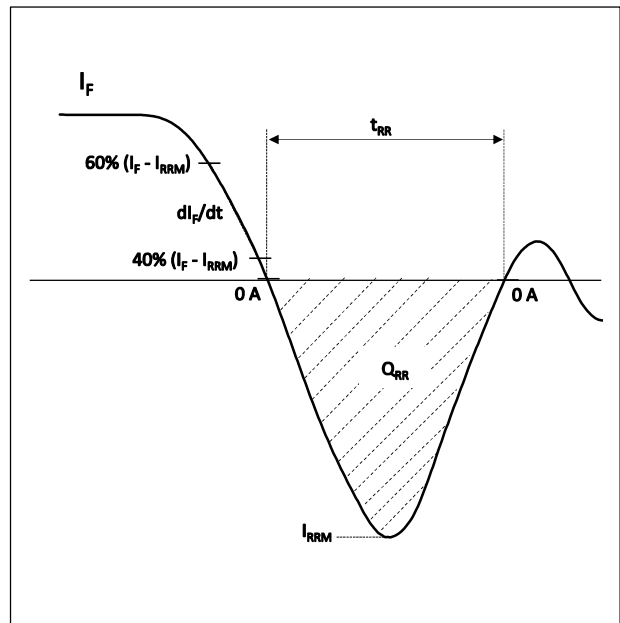

Figure 32. Reverse Recovery Definitions

# 1200V SiC Full-Bridge Module

# GCMX020A120B3H1P

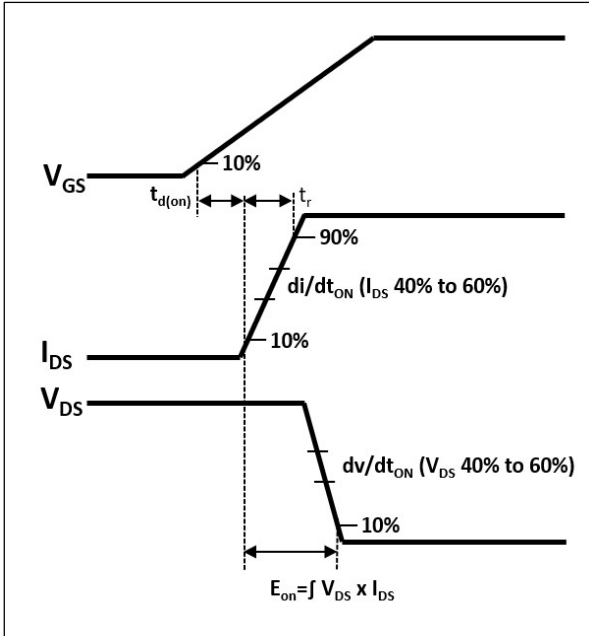

Figure 33. Turn-on Transient Definitions

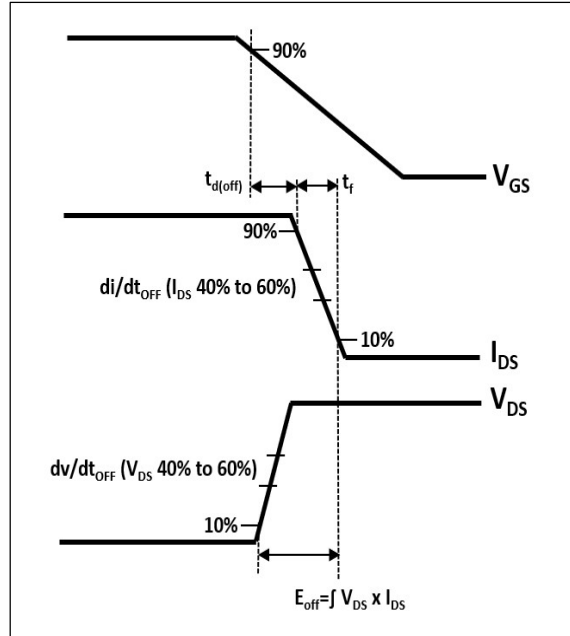
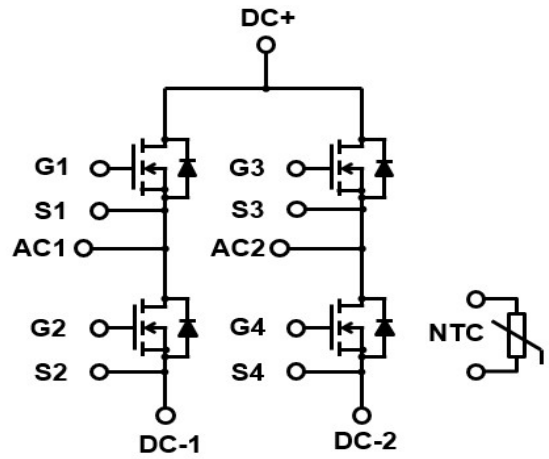
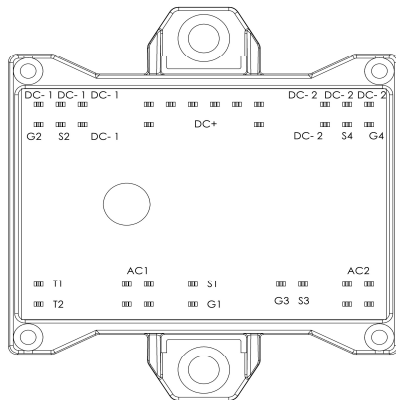

Figure 34. Turn-off Transient Definitions

# 1200V SiC Full-Bridge Module

**GCMX020A120B3H1P**

## Pinout and Circuit Diagram



## Package Dimensions (mm)

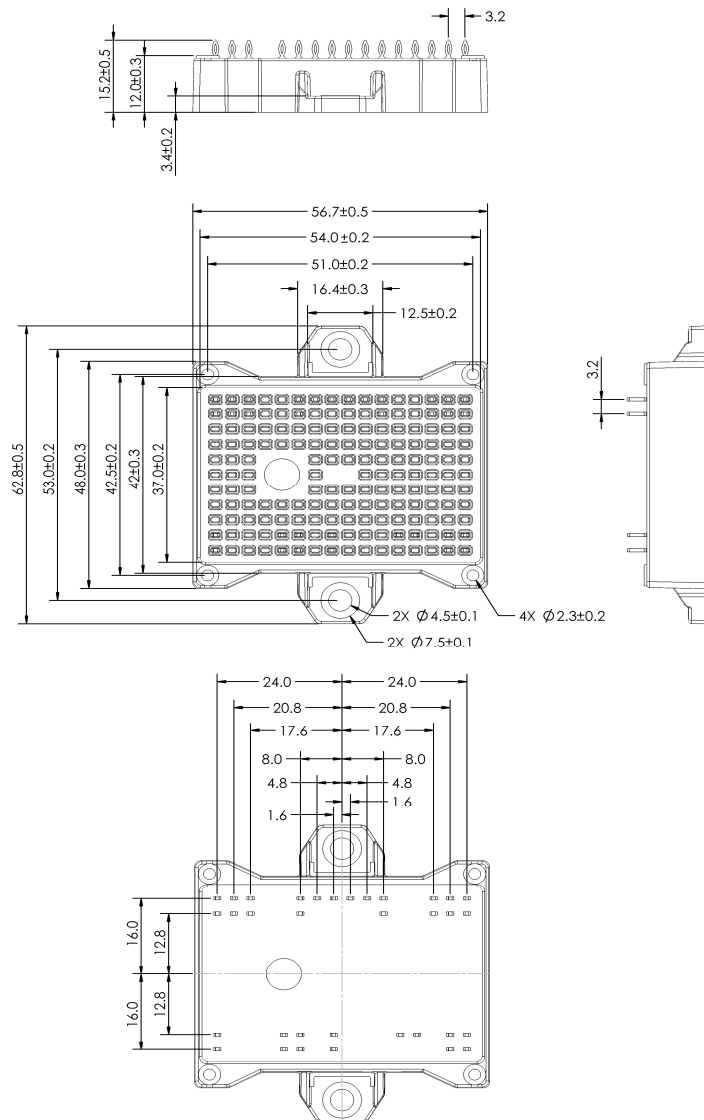

# 1200V SiC Full-Bridge Module

**GCMX020A120B3H1P**

| Revision History |          |                     |
|------------------|----------|---------------------|
| Date             | Revision | Notes               |
| 6/9/2023         | 0.1      | Preliminary release |
| 7/28/2023        | 1.0      | Initial release     |
|                  |          |                     |

## Notes

### **RoHS Compliance**

The levels of RoHS restricted materials in this product are below the maximum concentration values (also referred to as the threshold limits) permitted for such substances, or are used in an exempted application, in accordance with EU Directive 2011/65/EC (RoHS2), as implemented March, 2013. RoHS Declarations for this product can be obtained from the Product Documentation sections of [www.SemiQ.com](http://www.SemiQ.com).

### **REACH Compliance**

REACH substances of high concern (SVHC) information is available for this product. Since the European Chemicals Agency (ECHA) has published notice of their intent to frequently revise the SVHC listing for the foreseeable future, please contact our office at SemiQ Headquarters in Lake Forest, California to insure you get the most up-to-date REACH SVHC Declaration. REACH banned substance information (REACH Article 67) is also available upon request.

SemiQ Inc., reserves the right to make changes to the product specifications and data in this document without notice. SemiQ products are sold pursuant to SemiQ's terms and conditions of sale in place at the time of order acknowledgement.

This product has not been designed or tested for use in, and is not intended for use in, applications implanted into the human body nor in applications in which failure of the product could lead to death, personal injury or property damage, including but not limited to equipment used in the operation of nuclear facilities, life-support machines, cardiac defibrillators or similar emergency medical equipment, aircraft navigation or communication or control systems, or air traffic control.

SemiQ makes no warranty, representation or guarantee regarding the suitability of its products for any particular purpose, nor does SemiQ assume any liability arising out of the application or use of any product or circuit, and specifically disclaims any and all liability, including without limitation special, consequential or incidental damages. Buyer is responsible for its products and applications using SemiQ products.

To obtain additional technical information or to place an order for this product, please contact us. The information in this datasheet is provided by SemiQ. SemiQ reserves the right to make changes, corrections, modifications, and improvements of datasheet without notice.