

# for Automotive Electronics

# SPECIFICATIONS

<b>Customer</b>	
<b>Product Name</b>	<b>Wire Wound Common Mode Choke Coil</b>
<b>Sunlord Part Number</b>	<b>AMCW4532B Series</b>
<b>Customer Part Number</b>	

New Released,  Revised]

SPEC No.: **AMCW01210000**

【This SPEC is total 13 pages.】

【ROHS Compliant Parts】

Approved By	Checked By	Issued By

## Shenzhen Sunlord Electronics Co., Ltd.

Address: Sunlord Industrial Park, Dafuyuan Industrial Zone, Baoan, Shenzhen, China 518110  
Tel: 0086-755-29832333 Fax: 0086-755-82269029 E-Mail: sunlord@sunlordinc.com

**【For Customer approval Only】**

Date: \_\_\_\_\_

Qualification Status:  Full  Restricted  Rejected

Approved By	Verified By	Re-checked By	Checked By

Comments:

\_\_\_\_\_

Rev.	Date	Changed Contents	Change Reasons	Drawing	Check	Approval
01	/	New release	/	Yibing Lin	/	Lang Yu

for Automotive Electronics

**〈Content〉**

No.	Item	Page
1	Scope	4
2	Product Description and Identification (Part Number)	4
3	Electrical Characteristics	4
4	Shape and Dimensions	5
5	Test and Measurement Procedures	5~6
6	Reliability Test	7~8
7	Packaging and Storage	8~9
8	Warning and Attentions	10~11
9	Visual inspection Standard of Product	11
10	Recommended Soldering Technologies	12
11	Solder Volume	12
12	Circuit Design	12
13	Cleaning	12~13
14	Precautions	13

for Automotive Electronics

**1 Scope**

1.1 Scope of parts

This specification applies to the AMCW4532B Series of wire wound common mode choke coil for automotive electronics based on AECQ200.

1.2 Scope of application

Multimedia system, CAN-Bus, Industrial automation.

**2 Product Description and Identification (Part Number)**

1) Description:

AMCW4532B Series of Wire wound Common Mode Choke Coil.

2) Product Identification (Part Number)

**AMCW**    **4532**    **B**    **-2**    **-□□□**    **I**  
 ①            ②            ③            ④            ⑤            ⑥

① Type	
AMCW	Wire Wound Chip Common Mode Choke for Automotive

② External Dimensions [L X W] (mm)	
4532	4.5 X 3.2

③ Type Code	
B	CAN Bus
R	FlexRay

④ Number of Lines	
2	2 lines

⑤ Nominal Inductance (uH)	
Example	Nominal Value
110	11
220	22
510	51
101	100

⑥ Packing	
T	Tape & Reel

**3 Electrical Characteristics**

Part Number	Inductance (uH) +50%/-30%	DC Resistance (Ω) Max.	Rated Current (mA) Max.	Rated Voltage (VDC)	Insulation Resistance (MΩ) Min.	Operating Temperature Range
AMCW4532B-2-110T	11(@ 100KHz/0.1V)	0.5	360	50	10	-40 to +150°C
AMCW4532B-2-220T	22(@ 100KHz/0.1V)	0.8	310	50	10	-40 to +150°C
AMCW4532B-2-510T	51(@ 1.0MHz/0.1V)	1.0	230	50	10	-40 to +150°C
AMCW4532B-2-101T	100(@ 1.0MHz/0.1V)	2.0	200	50	10	-40 to +150°C

3.1 Storage temperature range (packaging conditions): -10°C~+40°C and RH 70% (Max.)

3.2 Typical Electrical Characteristics

**Impedance vs. Frequency**

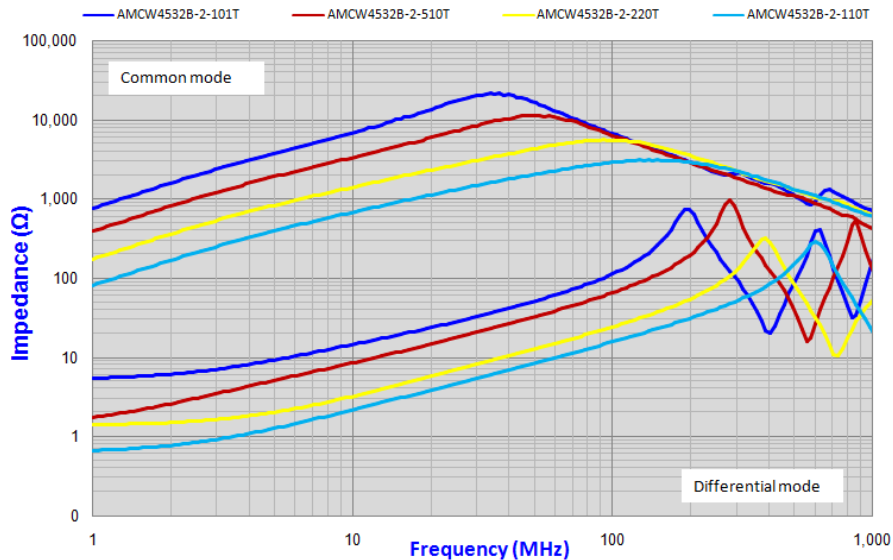

4 Shape and Dimensions

4.1 Structures: See Fig.4-1, Fig.4-2 and Table 4-1.

[Table 4-1]

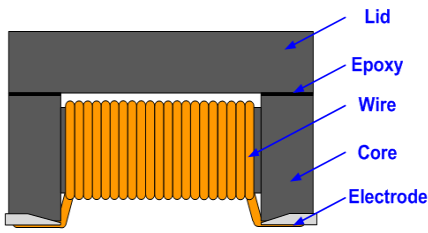

Fig.4-1

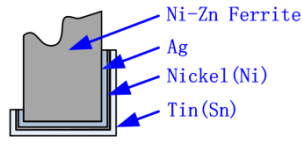

Fig.4-2

No.	Part Name	Material Name
①	Lid	Ni-Zn Ferrite
②	Epoxy	Epoxy resin
③	Wire	Polyurethane system enameled copper wire
④	Core	Ni-Zn Ferrite
⑤	Electrode structure	Ag+Ni+Sn plating

4.2 Dimensions: See Fig. 4-3.

4.3 Equivalent circuit: See Fig. 4-4.

4.4 Recommended PCB pattern for reflow soldering: See Fig. 4-5.

4.5 Electrode Coplanarity: 0.1mm Max.

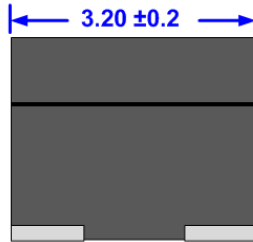
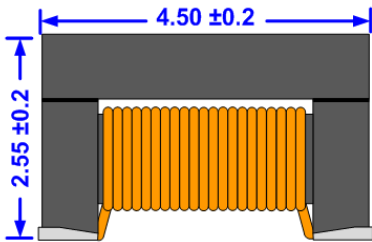

Unit: mm

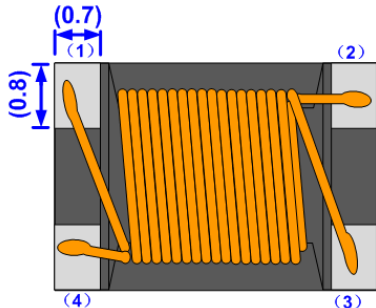

Fig.4-3

Equivalent Circuit

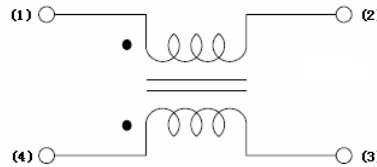

Fig.4-4

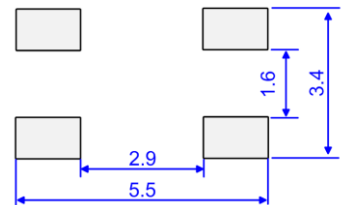

Fig.4-5

5 Test and Measurement Procedures

5.1 Test Conditions

5.1.1 Unless otherwise specified, the standard atmospheric conditions for measurement/test as:

- a. Ambient Temperature: 20±15°C
- b. Relative Humidity: 65±20%
- c. Air Pressure: 86kPa to 106kPa

5.1.2 If any doubt on the results, measurements/tests should be made within the following limits:

- a. Ambient Temperature: 20±2°C
- b. Relative Humidity: 65±5%
- c. Air Pressure: 86kPa to 106kPa

5.2 Visual Examination

Inspection Equipment: 10X microscope

5.3 Electrical Test

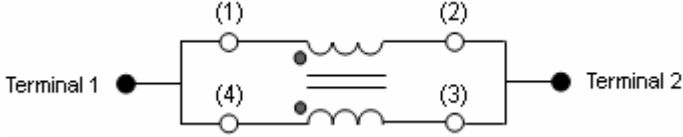
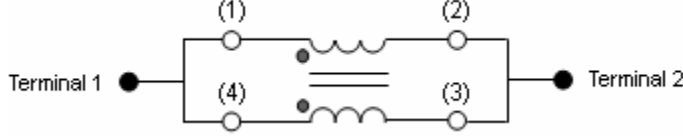
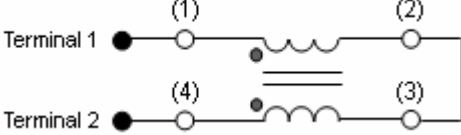
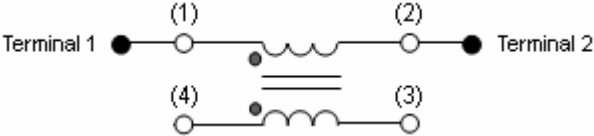
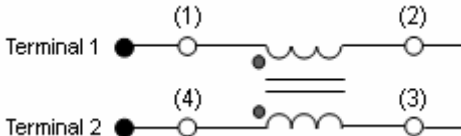
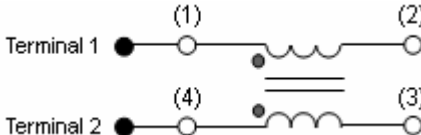
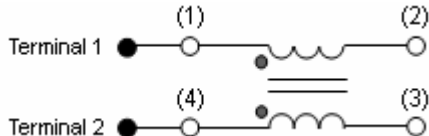
Items	Requirements	Test Methods and Remarks
5.3.1 Inductance (Common Mode)	Refer to <b>item 3. Electrical Characteristics</b>	Test equipment: High Accuracy RF LCR Meter Agilent4980A or equivalent. Common Mode Impedance is tested according to the following circuit. 
5.3.2 Impedance (Common Mode)	Refer to <b>item 3. Electrical Characteristics</b>	Test equipment: High Accuracy RF LCR Meter Agilent4287A/E4991A or equivalent. Common Mode Impedance is tested according to the following circuit. 
5.3.3 Impedance (Differential Mode)	Refer to <b>item 3. Electrical Characteristics</b>	Test equipment: High Accuracy RF LCR Meter Agilent4287A/E4991A or equivalent. Differential Mode Impedance is tested according to the following circuit. 
5.3.4 DC Resistance	Refer to <b>item 3. Electrical Characteristics</b>	Test equipment: High Accuracy Milliohm meter Agilent4338B/34420 or equivalent. DC Resistance is tested according to the following circuit. 
5.3.5 Rated Current	Refer to <b>item 3. Electrical Characteristics</b>	Test equipment: Electric Power, Electric current meter, Thermometer. Definition of Rated Current (I <sub>r</sub> ): I <sub>r</sub> is direct electric current as chip surface temperature rise just 20°C against chip initial surface temperature. Rated Current is tested according to the following circuit. 
5.3.6 Insulation Resistance	Refer to <b>item 3. Electrical Characteristics</b>	Test equipment: High resistance meter Agilent4339B. Insulation Resistance is tested according to the following circuit. 
5.3.7 Dielectric Strength	Refer to <b>item 3. Electrical Characteristics</b>	2.5 times Rated Voltage shall be applied between two coils for 1 minute and there shall be no dielectric breakdown (IR meet the specification). Dielectric Strength is tested according to the following circuit. 

6 Reliability Test

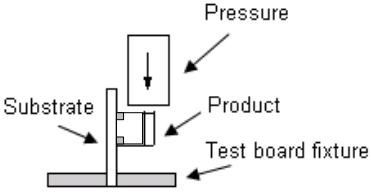
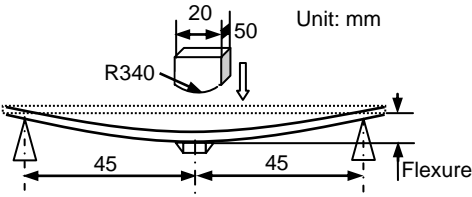
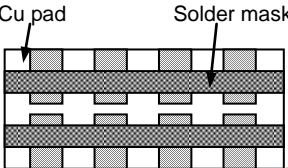
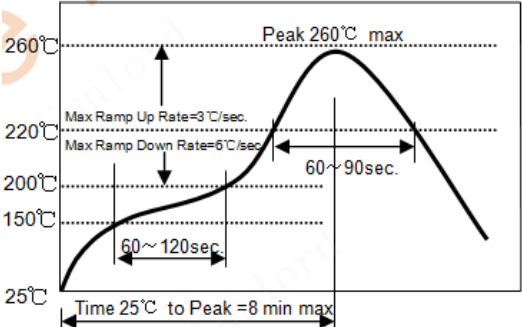
Item	Requirements	Test Methods and Remarks
6.1 Terminal strength	No removal or split of the termination or other defects shall occur.  	① Solder the chip to the testing jig (glass epoxy board) using eutectic solder. Then apply a force in the direction of the arrow. ② 17.7 N force. ③ Keep time: 60(+1) sec.
6.2 Resistance to Flexure	① No visible mechanical damage. ② Inductance change: within $\pm 20\%$ . ③ Insulation resistance: 10M $\Omega$ Min.  	① Solder the chip to the test jig (glass epoxy board) using a eutectic solder. Then apply a force in the direction shown as left. ② Flexure: 2mm. ③ Pressurizing speed: 0.5mm/sec. ④ Keep time: 60(+5) sec.
6.3 Vibration	① No visible mechanical damage. ② Inductance change: within $\pm 20\%$ . ③ Insulation resistance: 10M $\Omega$ Min.  	① Solder the chip to the testing jig (glass epoxy board) using eutectic solder. ② The chip shall be subjected to a simple harmonic motion having total amplitude of 1.5mm, the vibration acceleration of 5g, the frequency being varied uniformly between the approximate limits of 10 and 2000 Hz. ③ The frequency range from 10 to 2000 Hz and return to 10 Hz shall be traversed in approximately 20 minute. This motion shall be applied for a period of 4 hours in each 3 mutually directions (total of 12 hours).
6.4 Solderability	① Wetting shall be exceeded 90% coverage, except welding points.	① Steam aging 8h (pretreatment). ② Solder temperature: 260 $\pm 2^\circ\text{C}$ . ③ Duration: 4 $\pm 1$ sec. ④ Solder: Sn/3.0Ag/0.5Cu. ⑤ Flux: 25% resin and 75% ethanol in weight.
6.5 Resistance to soldering heat	① No visible mechanical damage. ② Inductance change: within $\pm 20\%$ . ③ Insulation resistance: 10M $\Omega$ Min.	① Reflow soldering ② The chip shall be stabilized at normal condition for 1~2 hours before measuring.  
6.6 Temperature Characteristics	① No visible mechanical damage. ② Inductance change: within $\pm 20\%$ . ③ Insulation resistance: 10M $\Omega$ Min.	① Temperature range: -40 $^\circ\text{C}$ ~+150 $^\circ\text{C}$ . ② Reference temperature: +20 $^\circ\text{C}$ .

Automotive Electronics Specifications for Wire Wound Common Mode Choke Coil

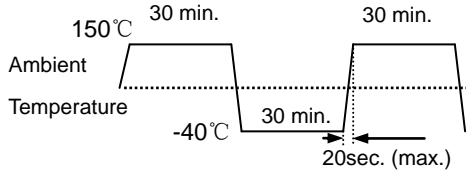
<p>6.7 Thermal shock</p>	<p>① No mechanical damage. ② Inductance change: within <math>\pm 20\%</math>. ③ Insulation resistance: 10M<math>\Omega</math> Min.</p> 	<p>① Temperature, time: <math>-40^{\circ}\text{C}</math> for <math>30\pm 3</math> min <math>\rightarrow +150^{\circ}\text{C}</math> for <math>30\pm 3</math> min. ② Transforming interval: 20 sec (max.). ③ Tested cycle: 1000 cycles. ④ The chip shall be stabilized at normal condition for 1~2 hours before measuring.</p>
<p>6.8 Resistance to low temperature</p>	<p>① No mechanical damage. ② Inductance change: within <math>\pm 20\%</math>. ③ Insulation resistance: 10M<math>\Omega</math> Min.</p>	<p>① Temperature: <math>-40\pm 2^{\circ}\text{C}</math> ② Duration: <math>1000^{+24}</math> hours. ③ The chip shall be stabilized at normal condition for 1~2 hours before measuring.</p>
<p>6.9 Resistance to high temperature</p>	<p>① No mechanical damage. ② Inductance change: within <math>\pm 20\%</math>. ③ Insulation resistance: 10M<math>\Omega</math> Min.</p>	<p>① Temperature: <math>150\pm 2^{\circ}\text{C}</math> ② Duration: <math>1000^{+24}</math> hours. ③ The chip shall be stabilized at normal condition for 1~2 hours before measuring.</p>
<p>6.10 Operation Life</p>	<p>① No visible mechanical damage. ② Inductance change: within <math>\pm 20\%</math>. ③ Insulation resistance: 10M<math>\Omega</math> Min.</p>	<p>① Temperature: <math>150\pm 2^{\circ}\text{C}</math>. ② Duration: <math>1000^{+24}</math> hours. ③ Applied current: Rated current. ④ The chip shall be stabilized at normal condition for 1~2 hours before measuring.</p>
<p>6.11 Mechanical Shock</p>	<p>① No visible mechanical damage. ② Inductance change: within <math>\pm 20\%</math>. ③ Insulation resistance: 10M<math>\Omega</math> Min.</p>	<p>① Half sinusoid, the peak acceleration: 1500g. ② Pulse width: 0.5 ms. ③ This motion shall be applied for 6 times in each 3 mutually directions (total of 18 times).</p>
<p>6.12 ESD</p>	<p>① No visible mechanical damage. ② Inductance change: within <math>\pm 20\%</math>. ③ Insulation resistance: 10M<math>\Omega</math> Min.</p>	<p>Contact discharge, 8 KV, twice, one in the positive polarity and the other in the negative polarity.</p>
<p>6.13 Biased Humidity</p>	<p>① No visible mechanical damage. ② Inductance change: within <math>\pm 20\%</math>. ③ Insulation resistance: 10M<math>\Omega</math> Min.</p>	<p>① Temperature: <math>85\pm 2^{\circ}\text{C}</math>. ② Humidity: 85% RH. ③ Duration: <math>1000^{+24}</math> hours. ④ Applied current: Rated current. ⑤ The chip shall be stabilized at normal condition for 1~2 hours before measuring.</p>

7 Packaging and Storage

7.1 Packaging

There is one type of packaging for the chip chokes. Please specify the packing code when ordering.

Tape Carrier Packaging:

Packaging code: T

- i. Tape carrier packaging are specified in attached figure Fig. 6.1-1~4
- ii. Tape carrier packaging quantity please see the following table:

Type	AMCW4532B
Tape	Embossed Tape
Quantity	2K

(1) Taping Drawings (Unit: mm)

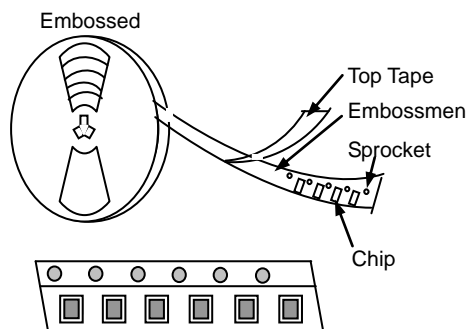

Fig. 6.1-1



Automotive Electronics Specifications for Wire Wound Common Mode Choke Coil

Remark: The sprocket holes are to the right as the tape is pulled toward the user, and the packaging is non moisture proof and non anti-static.

(2) Taping Dimensions (Unit: mm)

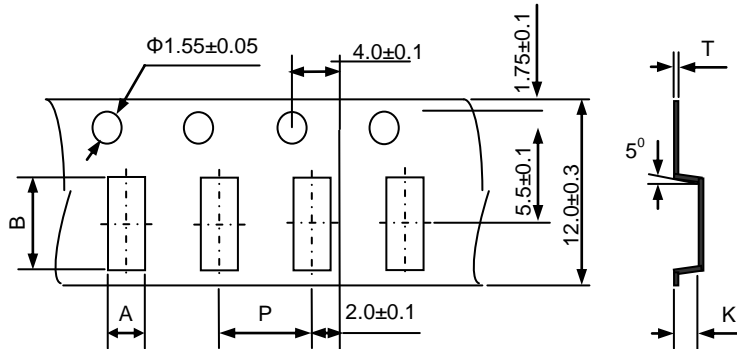

Fig. 6.1-2

Type	A	B	P	K	T
4532	3.51±0.1	4.82±0.1	8.0±0.1	3.05±0.1	0.35±0.05

(3) Reel Dimensions (Unit: mm)

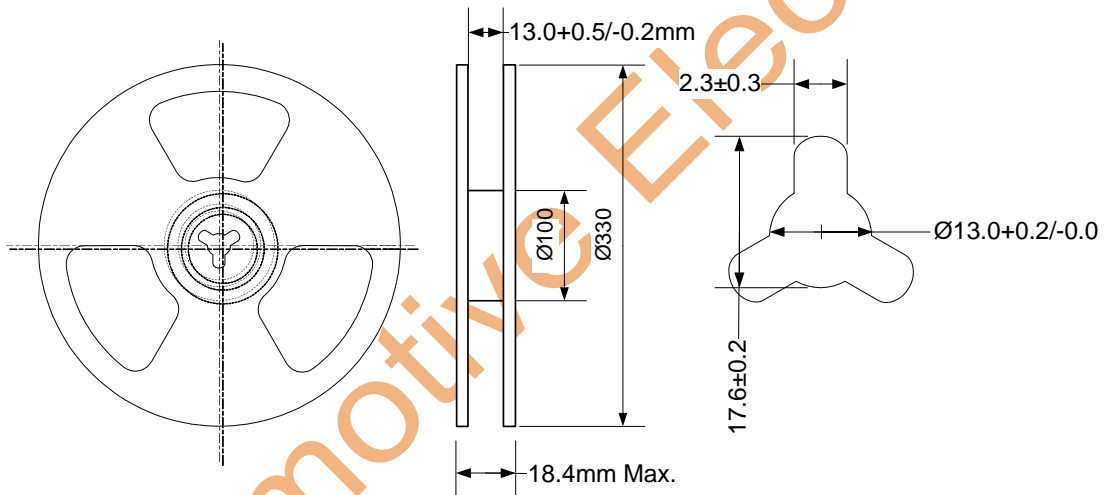

Fig. 6.1-3

(4) Peeling off force: 10gf to 70gf in the direction show below.

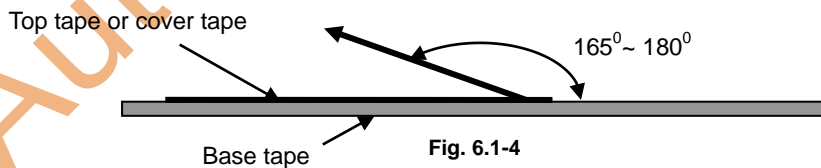

Fig. 6.1-4

7.2 Storage

- a. The solder ability of the external electrode may be deteriorated if packages are stored where they are exposed to high temperature or high humidity. Besides, to ensure packing material's good state, packages must be stored at -10°C to 40°C and 70% RH.
- b. The solder ability of the external electrode may be deteriorated if packages are stored where they are exposed to dust or harmful gas (e.g. HCl, sulfurous gas of H<sub>2</sub>S).
- c. Packaging materials may deform if packages are exposed directly to sunlight.
- d. Minimum packages, such as polyvinyl heat-seal packages shall not be opened until they are used. If opened, use the reels as soon as possible.
- e. Solderability shall be guaranteed for 12 months from the date of delivery on condition that they are stored at the environment specified in specification. For those parts, which passed more than the time shall be checked solder-ability before use.

7.3 Transportation

The cases shall not be damaged, destroyed and rained on.

8 Warning and Attention

8.1 General Handling Precautions

- a. Handling
  - i. Always wear static control bands to protect against ESD.
  - ii. Any devices used (soldering iron, measuring instruments) should be properly grounded.
  - iii. Use non-magnetic tweezers when handing the chips.
- b. Breakaway PC boards(splitting along perforations)
  - i. When splitting the PCB after mounting product, care should be taken not to give any stresses of deflection or twisting to the board.
  - ii. Board separation should not be done manually, but by using the appropriate devices.
- c. Mechanical considerations
  - i. Please do not give the product any excessive mechanical shocks.
  - ii. Please do not add any shock and power to a product in transportation.
- d. Pick-up pressure
  - i. Please do not push to add any pressure to a winding part; please do not give any shock and push into a ferrite core exposure part

8.2 Precautions on Use

- a. Always wear static control bands to protect against ESD.
- b. Any devices used (soldering iron, measuring instruments) should be properly grounded.
- c. Use non-magnetic tweezers when handing the chips.
- d. Pre-heating when soldering, and refer to the recommended condition specified in specification.
- e. Don't apply current in excess of the rated current value. It may cause damage to components due to over-current.
- f. Keep clear of anything that may generate magnetic fields such as speakers, coils.
- g. When soldering, the electrical characteristics (such as impedance) may be varied due to hot energy and mechanical stress.
- h. When coating products with resin, the relatively high resin curing stress may change the electrical characteristics. For exterior coating, select resin carefully so that electrical and mechanical performance of the product is not affected. Before using, please evaluate reliability with the product mounted in your application set.
- i. When mount chips with adhesive in preliminary assembly, do appropriate check before the soldering stage, i.e., the size of land pattern, type of adhesive, amount applied, hardening of the adhesive on proper usage and amounts of adhesive to use.
- j. Mounting density: Add special attention to radiating heat of products when mounting other components nearby. The excessive heat by other products may cause deterioration at joint of this product with substrate.
- k. Since some products are constructed like an open magnetic circuit, narrow spacing between components may cause magnetic coupling.
- l. Please do not give the product any excessive mechanical shocks in transportation.
- m. Please do not touch wires by sharp terminals such as tweezers to avoid causing any damage to wires.
- n. Please do not add any shock and power to the soldered product to avoid causing any damage to chip body.
- o. Please do not touch the electrodes by naked hand as the solderability of the external electrodes may deteriorate by grease or oil on the skin.
- p. Please do not use the brush to clean product or its surroundings. If you use the brush to clean product or its surroundings on PCB, copper wire may be broke, causing the product open.
- q. When the peripheral components are repaired, the product should be protected and avoid heating.

8.3 PCB Bending Design

The following shall be considered when designing and laying out PCB's.

- a. PCB shall be designed so that products are not subjected to the mechanical stress from board warp or deflection.

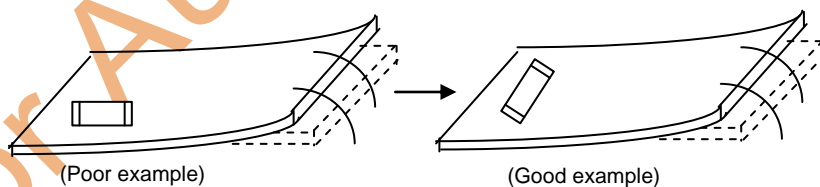

Products shall be located in the sideways direction to the mechanical stress.

- b. Products location on PCB separation.

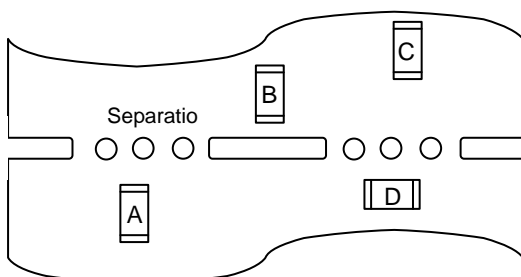

Product shall be located carefully because they may be subjected to the mechanical stress in order of A>C=B>D.

- c. When splitting the PCB board, or insert (remove) connector, or fasten thread after mounting components, care is required so as not to give any stress of deflection or twisting to the board. Because mechanical force may cause deterioration of the bonding strength of electrode and solder, even crack of product body. Board separation should not be done manually, but by using appropriate devices.

**8.4 Recommended PCB Design for SMT Land-Patterns**

When chips are mounted on a PCB, the amount of solder used (size of fillet) and the size of PCB Land-Patterns can directly affect chip performance. Therefore, the following items must be carefully considered in the design of solder land patterns.

- a. Please use the PCB pad and solder paste we recommend, and contact us in advance if they need to be changed.
- b. Please use flux contained with resin since the highly acidic (Chlorine content more than 0.2 wt%) or water-soluble one could damage the insulation film of wires, then causing short circuit of parts.
- c. The amount of solder applied can affect the ability of chips to withstand mechanical stresses which may lead to breaking or cracking. Therefore, when designing land-patterns it is necessary to consider the appropriate size and configuration of the solder pads which in turn determines the amount of solder necessary to form the fillets.
- d. When more than one part is jointly soldered onto the same land or pad, the pad must be designed that each component's soldering point is separated by solder-resist.

**Recommended land dimensions please refer to product specification.**

**9 Visual inspection standard of product**

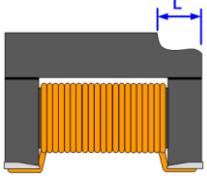
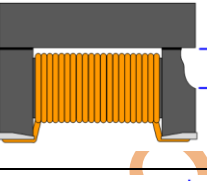
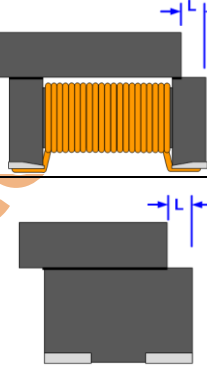
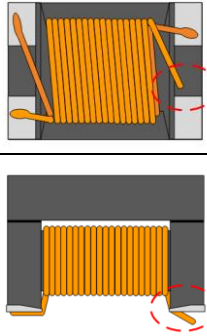
File No:		Applied to Wire Wound Common Mode Choke Coil	
Effective date:			
No.	Defect Item	Graphic	Rejection identification
1	Cover defect		For 4532 size, $L \geq 0.40\text{mm}$ , NG $L$ : defect maximum length
2	Core defect		For 4532size, $L \geq 0.40\text{mm}$ , NG $L$ : defect maximum length
3	Cover skewing		$L \geq 0.30\text{mm}$ , NG $L$ : offset distance between cover and core
4	Wire off		The solder joint of wire break away from electrodes

**10 Recommended Soldering Technologies**

This product is only for reflow soldering and iron soldering.

**10.1 Re-flowing Profile**

- △ Preheat condition: 150~200°C/60~120sec.
- △ Allowed time above 220°C: 60~90sec.
- △ Peak temp: 245~260°C
- △ Max time at peak temp: 10sec.
- △ Solder paste: Sn/3.0Ag/0.5Cu
- △ Allowed Reflow time: 3 times max.

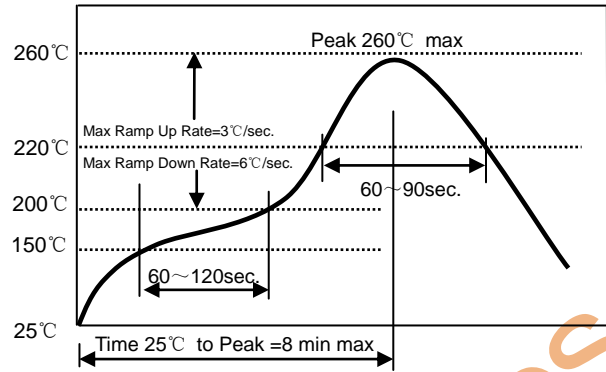

[Note: The reflow profile in the above table is only for qualification and is not meant to specify board assembly profiles. Actual board assembly profiles must be based on the customer's specific board design, solder paste and process, and should not exceed the parameters as the Reflow profile shows, otherwise, reflow verification should be carried out before using this common mode choke.]

**10.2 Iron Soldering Profile**

- △ Iron soldering power: 30W Max.
- △ Preheat condition: 150°C/60sec.
- △ Soldering tip temperature: 350°C Max.
- △ Soldering time: 3sec. Max.
- △ Solder paste: Sn/3.0Ag/0.5Cu
- △ Iron Soldering time: 1 time max.

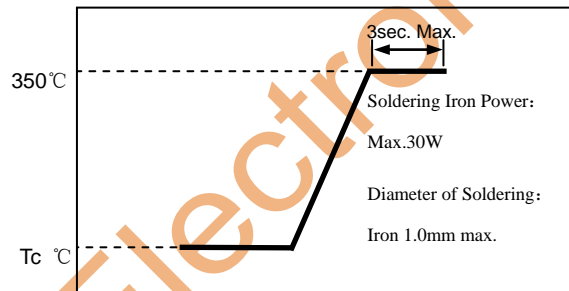

[Note: Take care not to apply the tip of the soldering iron to the terminal electrodes.]

**10.3 Maintenance of heat gun (for your reference)**

- △ Power output: 30W
- △ Temperature: 350°C Max
- △ Heat time: More than 5 seconds heating may cause short circuit of parts. And poor adhesive property of resin, meanwhile, the external force produced by heat gun could lead to separation between magnetic core and lid.

**11 Solder Volume**

- a. Accordingly increasing the solder volume, the mechanical stress to chip is also increased. Exceeding solder volume may cause the failure of mechanical or electrical performance.
- b. Before soldering, please ensure that the solder should not adhere to the wire part of chip.
- c. Please pay particular attention to whether there is flux remaining on surface of the wire part of chip after subjected to reflow soldering since this may causing short circuit of parts.

**12 Circuit Design**

Operating environment: The products described in this specification are intended for use in general electronic equipment, (office supply equipment, telecommunications systems, measuring equipment, and household equipment). They are not intended for use in mission-critical equipment or systems requiring special quality and high reliability (traffic systems, safety equipment, aerospace systems, nuclear control systems and medical equipment including life-support systems) where product failure might result in loss of life injury or damage. For such uses, contact Sunlord Sales Department in advance

**13 Cleaning**

Products shall be cleaned on the following conditions:

- a. Cleaning temperature shall be limited to 60°C Max. (40°C Max. for fluoride and alcohol type cleaner.)
- b. Ultrasonic cleaning shall comply with the following conditions, avoiding the resonance phenomenon at the mounted products and PCB.
  - Power: 20W/l Max.
  - Frequency: 28 KHz to 40 KHz
  - Time: 5 minutes Max
- c. Cleaner
  - i. Alternative cleaner
    - Isopropyl alcohol (IPA)
    - HCFC-225
  - ii. Aqueous agent
    - Surface Active Agent Type (Clean through-750H)

**Automotive Electronics Specifications for Wire Wound Common Mode Choke Coil**

- Hydrocarbon Type (Techno Cleaner-335)
  - Higher Alcohol Type (Pine Alpha ST-100S)
  - Alkali saponifier Type (※ Aqua Cleaner 240)
    - ※ Alkali saponification shall be diluted to 20% volume with de-ionized water.
  - ※ Please contact our technical service department before using other cleaner.
- d. There shall be no residual flux and residual cleaner after cleaning. In the case of using aqueous agent, product shall be dried completely after rinse with de-ionized water in order to remove the cleaner.
- e. Some products may become slightly whitened. However, product performance or usage is not affected.
- f. Please take care of winding part while cleaning.
- g. After cleaning, parts could be subjected to the next reflow soldering till the solvent remaining on surface of parts being volatilized.

**14 Precautions****14.1 Surface mounting**

- Mounting and soldering condition should be checked beforehand.
- Applicable soldering process to this product is reflow soldering only.
- Recommended conditions for repair by soldering iron:
  - Preheat the circuit board with product to repair at 150°C for about 1 minute.
  - Put soldering iron on the land-pattern.
  - Soldering iron's temperature: 350°C maximum/Duration: 3 seconds maximum/1 time for each terminal.
  - The soldering iron should not directly touch the inductor.
  - Product once removes from the circuit board may not be used again.

**14.2 Handing**

- Keep the products away from all magnets and magnetic objects.
- Be careful not to subject the products to excessive mechanical shocks.
- Please avoid applying impact to the products after mounted on pc board.
- Avoid ultrasonic cleaning.

**14.3 Storage**

- To maintain the solderability of terminal electrodes and to keep the packing material in good condition, temperature and humidity in the storage area should be controlled.
- Recommended conditions: -10°C~40°C, 70%RH (Max.)
- Even under ideal storage conditions, solderability of products electrodes may decrease as time passes. For this reason, product should be used with one year from the time of delivery.
- In case of storage over 6 months, solderability shall be checked before actual usage.

**14.4 Regarding Regulations**

- Any Class- I or Class-II ozone-depleting substance (ODS) listed in the Clean Air Act in US for regulation is not included in the products or applied to the products at any stage of whose manufacturing processes.
- Certain brominated flame retardants (PBBs, PBDEs) are not used at all.
- The products of this specification are not subject to the Export Trade Control Order in China or the Export Administration Regulations in US.

**14.5 Guarantee**

- The guaranteed operating conditions of the products are in accordance with the conditions specified in this specification.
- Please note that Sunlord takes no responsibility for any failure and/or abnormality which is caused by use under other than the aforesaid operating conditions.