

SPECIFICATIONS

Customer	
Product Name	Wire Wound Chip Common Mode Choke Coil
Sunlord Part Number	SDCW2012H-2-□□□TF
Customer Part Number	

New Released, Revised]

SPEC No.: **SDCW13160000**

【This SPEC is total 14 pages including specifications and appendix.】

【ROHS, Halogen-Free and SVHC Compliant Parts】

Approved By	Checked By	Issued By

Shenzhen Sunlord Electronics Co., Ltd.

Address: Sunlord Industrial Park, Dafuyuan Industrial Zone, Baoan, Shenzhen, China 518110
 Tel: 0086-755-29832333 Fax: 0086-755-82269029 E-Mail: sunlord@sunlordinc.com

【For Customer approval Only】

Date: _____

Qualification Status: Full Restricted Rejected

Approved By	Verified By	Re-checked By	Checked By

Comments:

【Version change history】

Rev.	Effective Date	Changed Contents	Change reasons	Approved By
01	/	New release	/	Jingxin Huang

【Precautions】

1. Magnetic materials shall be far away from parts to avoid impacts on their electrical characteristics;
2. Parts could be damaged by external mechanical pressure or stacked heavy objects, as well as strong shaking & dropping;
3. Please do not store parts in bulk to prevent coils and parts being damaged;
4. When parts are installed, pressure put on lids shall be no more than 5N. Otherwise, the lids would be damaged or cracked;
5. Oversized external force to parts on PCB may lead to parts being damaged or slipped off;
6. Please do not use parts on edge or top of PCB board in your design to avoid parts being damaged during PCB is moved.
7. Please use flux contained with resin since the highly acidic (Chlorine content more than 0.2 wt%) or water-soluble one could damage the insulation film of wires, then causing short circuit of parts.
8. Please do not use the brush to clean product or its surroundings. If you use the brush to clean product or its surroundings on PCB, copper wire may be broke, causing the product open .



Caution

All products listed in this specification are developed, designed and intended for use in general electronics equipment. The products are not designed or warranted to meet the requirements of the applications listed below, whose performance and/or quality require especially high reliability, or whose failure, malfunction or trouble might directly cause damage to society, person, or property. Please understand that we are not responsible for any damage or liability caused by use of the products in any of the applications below. Please contact us for more details if you intend to use our products in the following applications.

1. Aircraft equipment
2. Aerospace equipment
3. Undersea equipment
4. nuclear control equipment
5. military equipment
6. Power plant equipment
7. Medical equipment
8. Transportation equipment (automobiles, trains, ships, etc.)
9. Traffic signal equipment
10. Disaster prevention / crime prevention equipment
11. Data-processing equipment
12. Applications of similar complexity or with reliability requirements comparable to the applications listed in the above

1. Scope

This specification applies to SDCW2012-H series of Wire Wound Chip Common Mode Choke Coil for HDMI.

2. Product Description and Identification (Part Number)

- a) Description
Wire Wound Chip Common Mode Choke Coil for HDMI.
- b) Product Identification (Part Number)

SDCW **2012** **H** **-2** **-□□□** **I** **F**
 ① ② ③ ④ ⑤ ⑥ ⑦

① Type	
SDCW	Wire Wound Chip Common Mode Choke Coil

⑤ Common Mode Impedance (Ω)	
Example	Nominal Value
900	90

② External Dimensions [L X W] (mm)	
2012	2.0 X 1.2

⑥ Packing	
T	Tape & Reel

③ Product Classification Code	
H	For HDMI

⑦ HSF Products	
Hazardous Substance Free Products	

④ Number of Lines	
2	2 lines

3. Electrical Characteristics

Part Number	Impedance @ 100MHz (Ω)	DC Resistance (Ω) Max.	Rated Current (mA) Max.	Rated Voltage (VDC)	Insulation Resistance (MΩ) Min.
SDCW2012H-2-670TF	67±25%	0.30	320	20	10
SDCW2012H-2-900TF	90±25%	0.40	280	20	10
SDCW2012H-2-121TF	120±25%	0.40	280	20	10

- a) Operating and storage temperature range (individual chip without packing): -40°C~+85°C.
- b) Storage temperature range (packaging conditions): -10°C~+40°C and RH 70% (Max.)
- c) Typical Electrical Characteristics

Impedance vs. Frequency

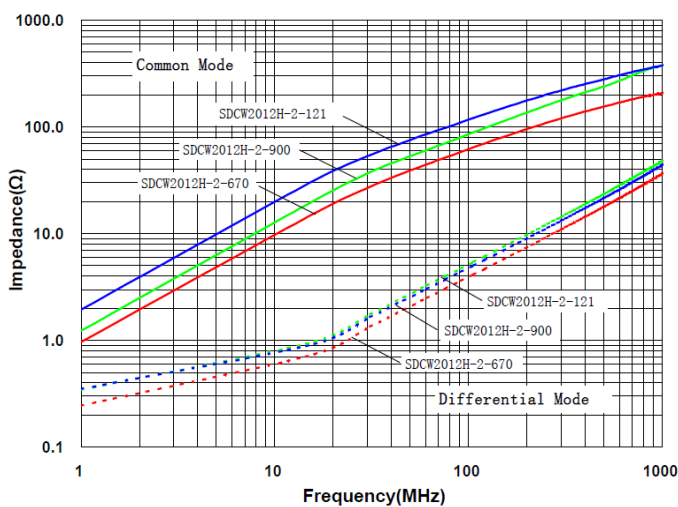

Insertion Loss

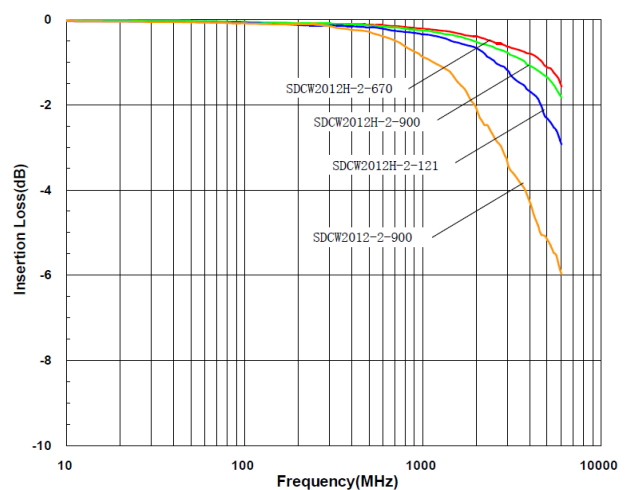

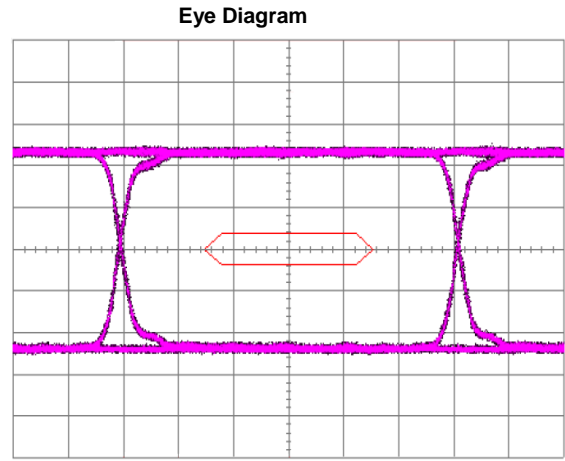
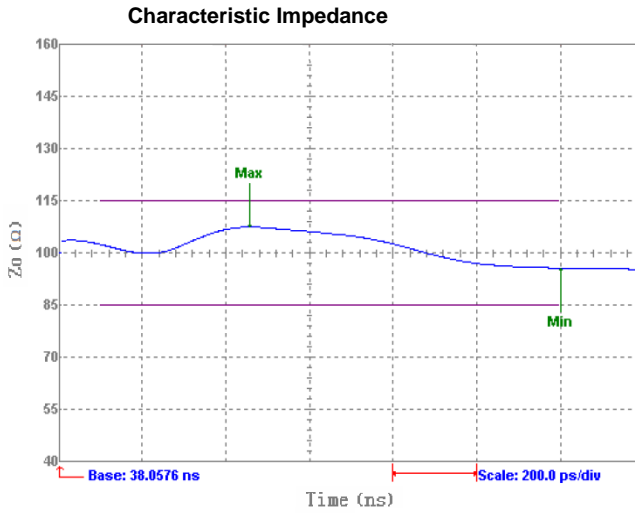

4. Shape and Dimensions

a) Structures: See Fig.4-1, Fig.4-2 and Table 4-2.

[Table 4-1]

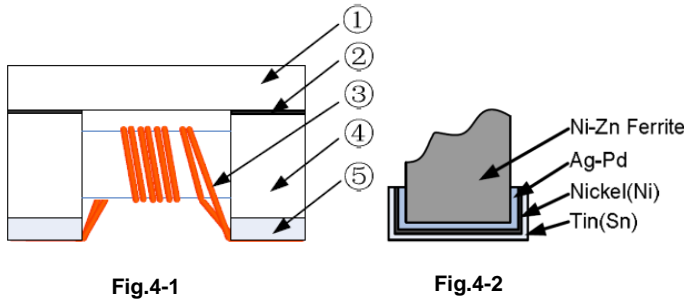

No.	Part Name	Material Name
①	Lid	Ni-Zn Ferrite
②	Epoxy	Epoxy resin
③	Wire	Polyurethane system enameled copper wire
④	Core	Ni-Zn Ferrite
⑤	Electrode structure	(Ag-Pd)+Ni+Sn plating

- b) Dimensions: See Fig. 4-3.
- c) Equivalent circuit: See Fig. 4-4.
- d) Recommended PCB pattern for reflow soldering: See Fig. 4-5.
- e) Electrode Coplanarity: 0.1mm Max.

Unite: mm

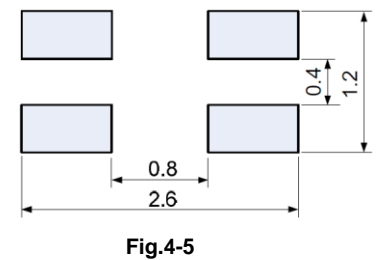
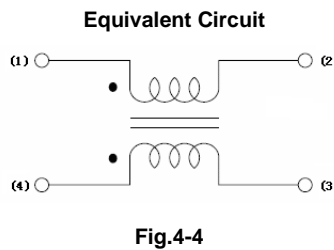
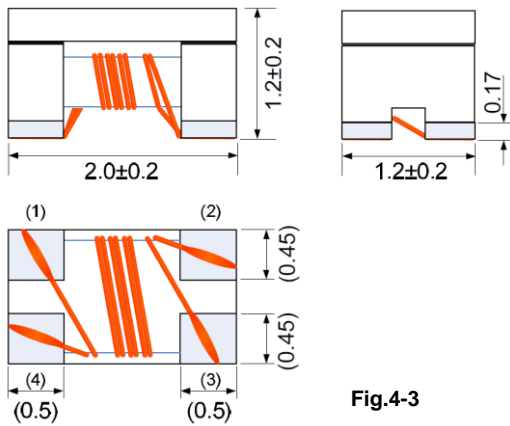

5. Test and Measurement Procedures

5.1 Test Conditions

Unless otherwise specified, the standard atmospheric conditions for measurement/test as:

- a. Ambient Temperature: 20±15℃.
- b. Relative Humidity: 65±20%.
- c. Air Pressure: 86 KPa to 106 KPa.

If any doubt on the results, measurements/tests should be made within the following limits:

- a. Ambient Temperature: 20±2℃.
- b. Relative Humidity: 65±5%.
- c. Air Pressure: 86KPa to 106 KPa.

5.2 Visual Examination

- a. Inspection Equipment: microscope.

5.3 Electrical Test

Items	Requirements	Test Methods and Remarks
5.3.1 Impedance (Common Mode)	Refer to item 3. Electrical Characteristics	Test equipment: High Accuracy RF LCR Meter Agilent4287A/E4991A or equivalent. Common Mode Impedance is tested according to the following circuit.
5.3.2 Impedance (Differential Mode)	Refer to item 3. Electrical Characteristics	Test equipment: High Accuracy RF LCR Meter Agilent4287A/E4991A or equivalent. Differential Mode Impedance is tested according to the following circuit.
5.3.3 DC Resistance	Refer to item 3. Electrical Characteristics	Test equipment: High Accuracy Milliohm meter Agilent4338B/34420 or equivalent. DC Resistance is tested according to the following circuit.
5.3.4 Rated Current	Refer to item 3. Electrical Characteristics	Test equipment: Electric Power, Electric current meter, Thermometer. Definition of Rated Current (I _r): I _r is direct electric current as chip surface temperature rise just 20°C against chip initial surface temperature. Rated Current is tested according to the following circuit.
5.3.5 Insertion Loss	Refer to item 3. Electrical Characteristics	Test equipment: S-parameter Network Analyzer AgilentE5071C or equivalent. Insertion Loss is S ₂₁ mag tested according to the following circuit.
5.3.6 Insulation Resistance	Refer to item 3. Electrical Characteristics	Test equipment: High resistance meter Agilent4339B. Insulation Resistance is tested according to the following circuit.
5.3.7 Dielectric Strength	Refer to item 3. Electrical Characteristics	2.5 times Rated Voltage shall be applied between two coils for 1 minute and there shall be no dielectric breakdown (IR meet the specification). Dielectric Strength is tested according to the following circuit.

5.4 Reliability Test

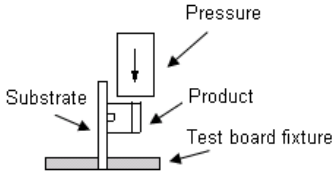
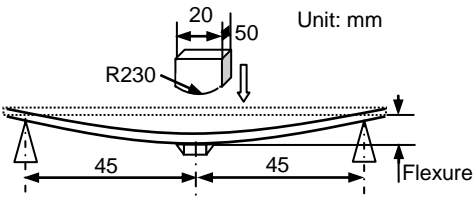
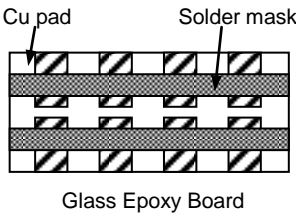
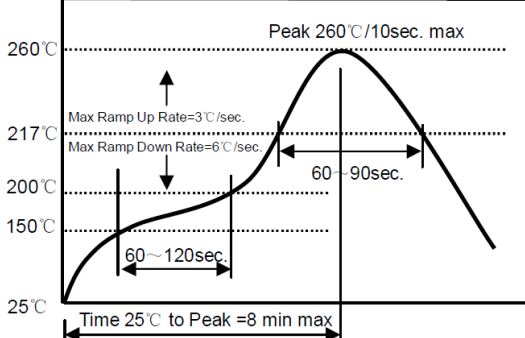
Item	Requirements	Test Methods and Remarks
5.4.1 Terminal strength	No removal or split of the termination or other defects shall occur. 	① Solder the chip to the testing jig (glass epoxy board) using leadfree solder. Then apply a force in the direction of the arrow. ② 5N force. ③ Keep time: 30±1s.
5.4.2 Resistance to Flexure	No visible mechanical damage. 	① Solder the chip to the test jig (glass epoxy board) using a leadfree solder. Then apply a force in the direction shown as left. ② Flexure: 2mm. ③ Pressurizing Speed: 0.5mm/sec. ④ Keep time: 5sec.
5.4.3 Vibration	No visible mechanical damage. 	① Solder the chip to the testing jig (glass epoxy board) using leadfree solder. ② The chip shall be subjected to a simple harmonic motion having total amplitude of 1.5mm, the frequency being varied uniformly between the approximate limits of 10 and 55 Hz. ③ The frequency range from 10 to 55 Hz and return to 10 Hz shall be traversed in approximately 1 minute. This motion shall be applied for a period of 2 hours in each 3mutually perpendicular directions (total of 6 hours).
5.4.4 Dropping	No visible mechanical damage.	Drop the chip 3 times on a concrete floor from a height of 100 cm.
5.4.5 Solder ability	Wetting shall be exceeded 90% coverage, except welding points.	① Solder temperature: 240±2℃. ② Duration: 4±1sec. ③ Solder: Sn/3.0Ag/0.5Cu. ④ Flux: 25% Resin and 75% ethanol in weight.
5.4.6 Resistance to soldering heat	① No visible mechanical damage. ② Impedance change: within ±20%. ③ Insulation Resistance: 10MΩ Min.	① Reflow soldering. ② The chip shall be stabilized at normal condition for 1~2 hours before measuring. 

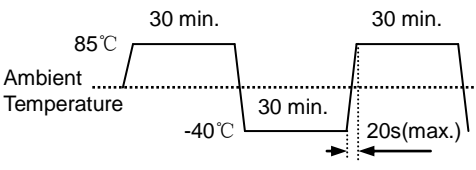
<p>5.4.7 Temperature Characteristics</p>	<p>① No visible mechanical damage. ② Impedance change: within $\pm 20\%$. ③ Insulation Resistance: 10MΩ Min.</p>	<p>① Temperature range: -40$^{\circ}$C~+85$^{\circ}$C. ② Reference temperature: +20$^{\circ}$C.</p>
<p>5.4.8 Thermal shock</p>	<p>① No mechanical damage. ② Impedance change: within $\pm 20\%$. ③ Insulation Resistance: 10MΩ Min.</p> 	<p>① Temperature, time: -40$^{\circ}$C for 30\pm3 min \rightarrow 85$^{\circ}$C for 30\pm3min. ② Transforming interval: 20 sec (max.). ③ Tested cycle: 250 cycles. ④ The chip shall be stabilized at normal condition for 1~2 hours before measuring.</p>
<p>5.4.9 Resistance to low temperature</p>	<p>① No mechanical damage. ② Impedance change: within $\pm 20\%$. ③ Insulation Resistance: 10MΩ Min.</p>	<p>① Temperature: -40\pm2$^{\circ}$C ② Duration: 500$^{+12}$ hours. ③ The chip shall be stabilized at normal condition for 1~2 hours before measuring.</p>
<p>5.4.10 Resistance to high temperature</p>	<p>① No mechanical damage. ② Impedance change: within $\pm 20\%$. ③ Insulation Resistance: 10MΩ Min.</p>	<p>① Temperature: 85\pm2$^{\circ}$C ② Duration: 500$^{+12}$ hours. ③ The chip shall be stabilized at normal condition for 1~2 hours before measuring.</p>
<p>5.4.11 Damp heat (Steady states)</p>	<p>① No visible mechanical damage. ② Impedance change: within $\pm 20\%$. ③ Insulation Resistance: 10MΩ Min.</p>	<p>① Temperature: 60\pm2$^{\circ}$C. ② Humidity: 90% to 95% RH. ③ Duration: 500$^{+12}$ hours. ④ The chip shall be stabilized at normal condition for 1~2 hours before measuring.</p>
<p>5.4.12 Loading under damp heat</p>	<p>① No visible mechanical damage. ② Impedance change: within $\pm 20\%$. ③ Insulation Resistance: 10MΩ Min.</p>	<p>① Temperature: 60\pm2$^{\circ}$C. ② Humidity: 90% to 95% RH. ③ Duration: 500$^{+12}$ hours. ④ Applied current: Rated current. ⑤ The chip shall be stabilized at normal condition for 1~2 hours before measuring.</p>
<p>5.4.13 Loading at high temperature (Life test)</p>	<p>① No visible mechanical damage. ② Impedance change: within $\pm 20\%$. ③ Insulation Resistance: 10MΩ Min.</p>	<p>① Temperature: 85\pm2$^{\circ}$C. ② Duration: 500$^{+12}$ hours. ③ Applied current: Rated current. ④ The chip shall be stabilized at normal condition for 1~2 hours before measuring.</p>

6. Packaging and Storage

6.1 Packaging

There is one type of packaging for the chip chokes. Please specify the packing code when ordering.

Tape Carrier Packaging:

Packaging code: T

- i. Tape carrier packaging are specified in attached figure Fig. 6.1-1~3
- ii. Tape carrier packaging quantity please see the following table:

Type	2012
Tape	Embossed Tape
Quantity	2K

(1) Taping Drawings (Unit: mm)

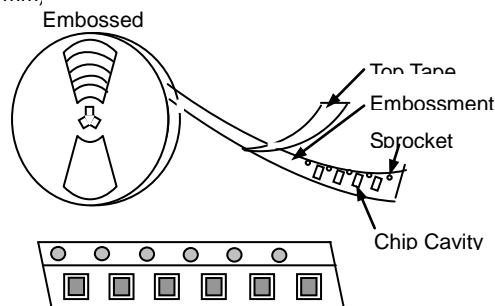

Fig. 6.1-1

Remark: The sprocket holes are to the right as the tape is pulled toward the user.

(2) Taping Dimensions (Unit: mm)

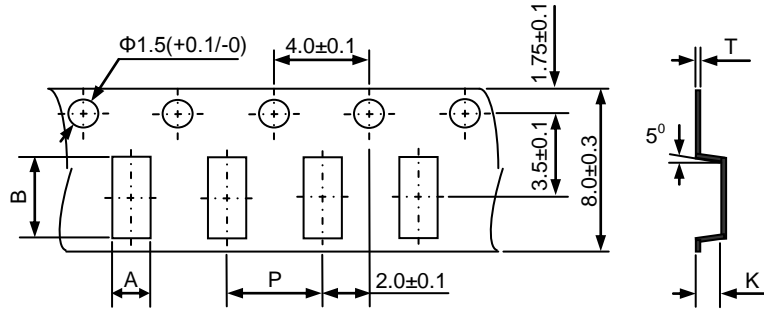

Fig. 6.1-2

Type	A	B	P	K	T
2012	1.55±0.2	2.25±0.2	4.0±0.1	1.45±0.1	0.2±0.1

(3) Leader and blank portion

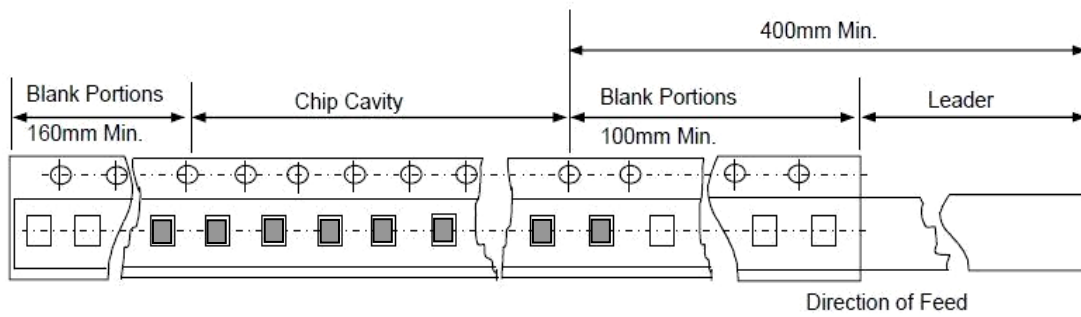

Fig. 6.1-3

(4) Reel Dimensions (Unit: mm)

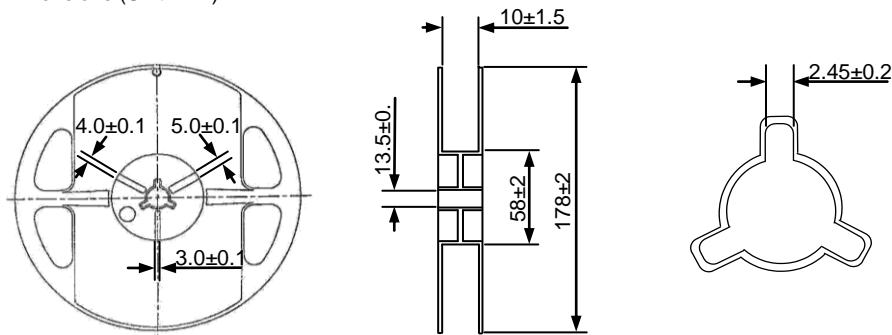

Fig. 6.1-4

(5) Peeling off force: 10gf to 70gf in the direction show below.

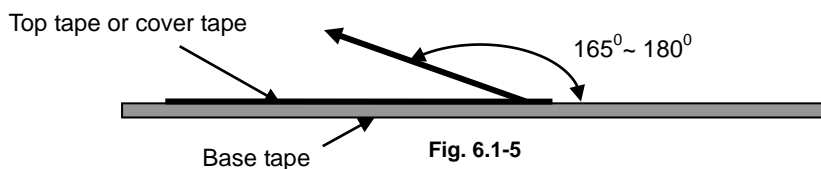

Fig. 6.1-5

6.2 Storage

- a. The solder ability of the external electrode may be deteriorated if packages are stored where they are exposed to high humidity or high temperature.
- b. The solder ability of the external electrode may be deteriorated if packages are stored where they are exposed to dust or harmful gas (e.g. HCl, sulfurous gas of H₂S).
- c. Packaging material may be deformed if package are stored where they are exposed to heat of direct sunlight.
- d. Minimum packages, such as polyvinyl heat-seal packages shall not be opened until they are used. If opened, use the reels as soon as possible.
- e. Solder ability shall be guaranteed for 12 months from the date of delivery on condition that they are stored at the environment specified in specification. For those parts, which passed more than the time shall be checked solder-ability before use.

6.3 Transportation

The cases shall not be damaged, destroyed and rained on.

7. Warning and Attention

7.1 General Handling Precautions

- a. Handling
 - i. Always wear static control bands to protect against ESD.
 - ii. Any devices used (soldering iron, measuring instruments) should be properly grounded.
 - iii. Use non-magnetic tweezers when handling the chips.
- b. Breakaway PC boards (splitting along perforations)
 - i. When splitting the PCB after mounting product, care should be taken not to give any stresses of deflection or twisting to the board.
 - ii. Board separation should not be done manually, but by using the appropriate devices.
- c. Mechanical considerations
 - i. Please do not give the product any excessive mechanical shocks.
 - ii. Please do not add any shock and power to a product in transportation.
- d. Pick-up pressure
 - i. Please do not push to add any pressure to a winding part; please do not give any shock and push into a ferrite core exposure part

7.2 Precautions on Use

- a. Always wear static control bands to protect against ESD.
- b. Any devices used (soldering iron, measuring instruments) should be properly grounded.
- c. Use non-magnetic tweezers when handling the chips.
- d. Pre-heating when soldering, and refer to the recommended condition specified in specification.
- e. Don't apply current in excess of the rated current value. It may cause damage to components due to over-current.
- f. Keep clear of anything that may generate magnetic fields such as speakers, coils.
- g. When soldering, the electrical characteristics (such as impedance) may be varied due to hot energy and mechanical stress.
- h. When coating products with resin, the relatively high resin curing stress may change the electrical characteristics. For exterior coating, select resin carefully so that electrical and mechanical performance of the product is not affected. Before using, please evaluate reliability with the product mounted in your application set.
- i. When mount chips with adhesive in preliminary assembly, do appropriate check before the soldering stage, i.e., the size of land pattern, type of adhesive, amount applied, hardening of the adhesive on proper usage and amounts of adhesive to use.
- j. Mounting density: Add special attention to radiating heat of products when mounting other components nearby. The excessive heat by other products may cause deterioration at joint of this product with substrate.
- k. Since some products are constructed like an open magnetic circuit, narrow spacing between components may cause magnetic coupling.
- l. Please do not give the product any excessive mechanical shocks in transportation.
- m. Please do not touch wires by sharp terminals such as tweezers to avoid causing any damage to wires.
- n. Please do not add any shock and power to the soldered product to avoid causing any damage to chip body.
- o. Please do not touch the electrodes by naked hand as the solder ability of the external electrodes may deteriorate by grease or oil on the skin.

7.3 PCB Bending Design

The following shall be considered when designing and laying out PCB's.

- a. PCB shall be designed so that products are not subjected to the mechanical stress from board warp or deflection.

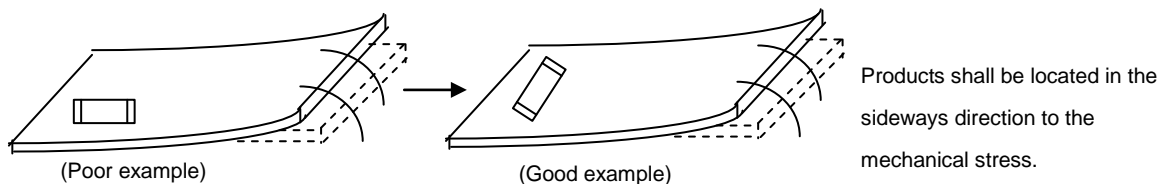

- b. Products location on PCB separation.

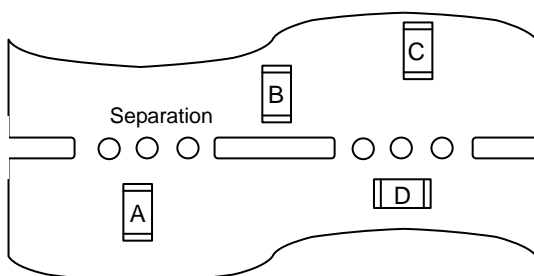

Product shall be located carefully because they may be subjected to the mechanical stress in order of $A > C = B > D$.

- c. When splitting the PCB board, or insert (remove) connector, or fasten thread after mounting components, care is required so as not to give any stress of deflection or twisting to the board. Because mechanical force may cause deterioration of the bonding strength of electrode and solder, even crack of product body. Board separation should not be done manually, but by using appropriate devices.

7.4 Recommended PCB Design for SMT Land-Patterns

When chips are mounted on a PCB, the amount of solder used (size of fillet) and the size of PCB Land-Patterns can directly affect chip performance. Therefore, the following items must be carefully considered in the design of solder land patterns.

- Please use the PCB pad and solder paste we recommend, and contact us in advance if they need to be changed.
- The amount of solder applied can affect the ability of chips to withstand mechanical stresses which may lead to breaking or cracking. Therefore, when designing land-patterns it is necessary to consider the appropriate size and configuration of the solder pads which in turn determines the amount of solder necessary to form the fillets.
- When more than one part is jointly soldered onto the same land or pad, the pad must be designed that each component's soldering point is separated by solder-resist.

Recommended land dimensions please refer to product specification.

8. Recommended Soldering Technologies

This product is only for reflow soldering and iron soldering.

8.1 Re-flowing Profile

- △ Preheat condition: 150~200°C/60~120sec.
- △ Allowed time above 217°C: 60~90sec.
- △ Max temp: 260°C
- △ Max time at max temp: 10sec.
- △ Solder paste: Sn/3.0Ag/0.5Cu
- △ Allowed Reflow time: 2 times max.

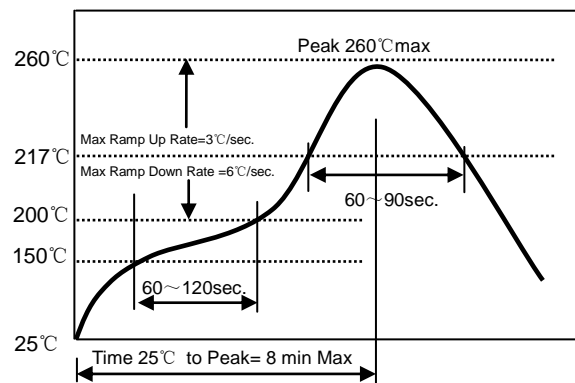

[Note: The reflow profile in the above table is only for qualification and is not meant to specify board assembly profiles. Actual board assembly profiles must be based on the customer's specific board design, solder paste and process, and should not exceed the parameters as the Reflow profile shows.]

8.2 Iron Soldering Profile

- △ Iron soldering power: 30W Max.
- △ Preheat condition: 150°C/60sec.
- △ Soldering tip temperature: 350°C Max.
- △ Soldering time: 3sec. Max.
- △ Solder paste: Sn/3.0Ag/0.5Cu
- △ Iron Soldering time: 1 time max.

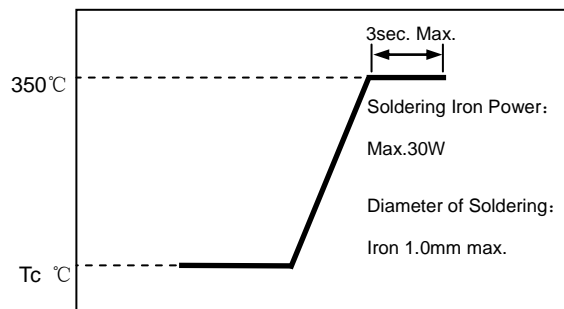

[Note: Take care not to apply the tip of the soldering iron to the terminal electrodes.]

8.3 Maintenance of heat gun (for your reference)

- △ Power output: 30W
- △ Temperature: 350°C Max
- △ Heat time: More than 5 seconds heating may cause short circuit of parts. And poor adhesive property of resin, meanwhile, the external force produced by heat gun could lead to separation between magnetic core and lid.

9. Solder Volume

Solder shall be used not to exceed as shown below.

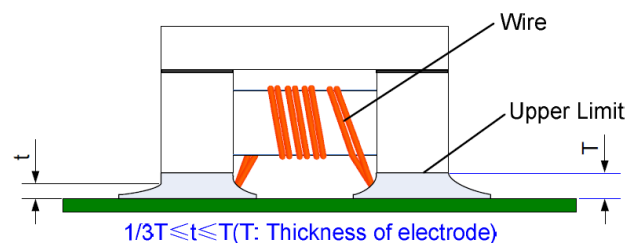

- a. Accordingly increasing the solder volume, the mechanical stress to chip is also increased. Exceeding solder volume may cause the failure of mechanical or electrical performance.
- b. Before soldering, please ensure that the solder should not adhere to the wire part of chip.
- c. Please pay particular attention to whether there is flux remaining on surface of the wire part of chip after subjected to reflow soldering since this may causing short circuit of parts.

10. Circuit Design

Operating environment: The products described in this specification are intended for use in general electronic equipment,(office supply equipment, telecommunications systems, measuring equipment, and household equipment). They are not intended for use in mission-critical equipment or systems requiring special quality and high reliability (traffic systems, safety equipment, aerospace systems, nuclear control systems and medical equipment including life-support systems) where product failure might result in loss of life injury or damage. For such uses, contact Sunlord Sales Department in advance

11. Cleaning

Products shall be cleaned on the following conditions:

- a. Cleaning temperature shall be limited to 60°C Max. (40°C Max. for fluoride and alcohol type cleaner.)
- b. Ultrasonic cleaning shall comply with the following conditions, avoiding the resonance phenomenon at the mounted products and PCB.
 - Power: 20W/l Max.
 - Frequency: 28 KHz to 40 KHz
 - Time: 5 minutes Max
- c. Cleaner
 - i. Alternative cleaner
 - Isopropyl alcohol (IPA)
 - HCFC-225
 - ii. Aqueous agent
 - Surface Active Agent Type (Clean through-750H)
 - Hydrocarbon Type (Techno Cleaner-335)
 - Higher Alcohol Type (Pine Alpha ST-100S)
 - Alkali saponifier Type (※ Aqua Cleaner 240)
 - ※ Alkali specification shall be diluted to 20% volume with de-ionized water.
 - ※ Please contact our technical service department before using other cleaner.
- d. There shall be no residual flux and residual cleaner after cleaning. In the case of using aqueous agent, product shall be dried completely after rinse with de-ionized water in order to remove the cleaner.
- e. Some products may become slightly whitened. However, product performance or usage is not affected.
- f. Please take care of winding part while cleaning.
- g. After cleaning, parts could be subjected to the next reflow soldering till the solvent remaining on surface of parts being volatilized.

Appendix A: Appearance standard

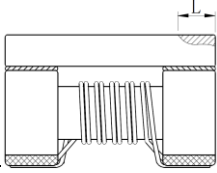
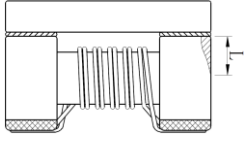
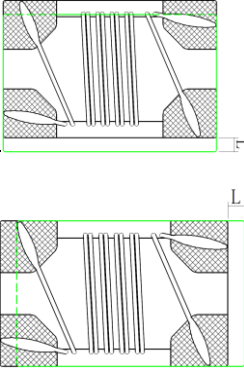
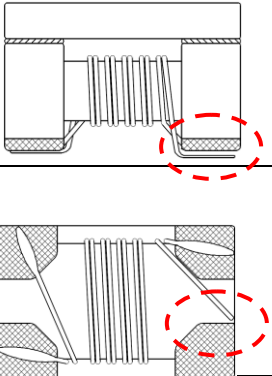
File No:		Applied to Wire Wound Common Mode Choke Coil	
Effective date:			
No.	Defect Item	Graphic	Rejection identification
1	Cover defect		For 2012 size, $L \geq 0.33\text{mm}$, NG L : defect maximum length
2	Core defect		For 2012 size, $L \geq 0.33\text{mm}$, NG L : defect maximum length
3	Cover skewing		$L \geq 0.27\text{mm}$, NG L : offset distance between cover and core
4	Wire off		The solder joint of wire break away from electrodes