

SPECIFICATIONS

Customer	/
Product Name	Assembled Large Current Choke Inductor
Sunlord Part Number	WPZ0906AS1
Customer Part Number	/
Weight	2.91 g/pcs Typ.

New Released Revised]

SPEC No.: WPZ05220000

【This SPEC is total 14 pages including specifications and appendix.】

【ROHS Compliant Parts】

Approved By	Checked By	Issued By

Shenzhen Sunlord Electronics Co., Ltd.

Address: Sunlord Industrial Park, Dafuyuan Industrial Zone, Guanlan, Shenzhen, China 518110
 Tel: +86-755-29832333 Fax: +86-755-82269029 E-Mail: sunlord@sunlordinc.com

【For Customer approval Only】 Date:

Qualification Status: Full Restricted Rejected

Approved By	Verified By	Re-checked By	Checked By

Comments:

【Version change history】

Rev.	Effective Date	Changed Contents	Change reasons	Approved By
01	/	New release	/	Jeffrey

Caution

All products listed in this specification are developed, designed and intended for use in general electronics equipment. The products are not designed or warranted to meet the requirements of the applications listed below, whose performance and/or quality require especially high reliability, or whose failure, malfunction or trouble might directly cause damage to society, person, or property. Please understand that we are not responsible for any damage or liability caused by use of the products in any of the applications below. Please contact us for more details if you intend to use our products in the following applications.

1. Aircraft equipment
2. Aerospace equipment
3. Undersea equipment
4. nuclear control equipment
5. military equipment
6. Power plant equipment
7. Medical equipment
8. Transportation equipment (automobiles, trains, ships, etc.)
9. Traffic signal equipment
10. Disaster prevention / crime prevention equipment
11. Data-processing equipment
12. Applications of similar complexity or with reliability requirements comparable to the applications listed in the above

〈Content〉

No.	Item	Page
1	Scope	5
2	Product Description and Identification (Part Number)	5
3	Shape and Dimensions	5
4	Electrical Characteristics	6
5	Test and Measurement Procedures	7
6	Structure and material list	7~8
7	Product Marking	8
8	Reliability Test	9
9	Packaging and Storage	10~11
10	Visual inspection standard of product	12
11	Recommended Soldering Technologies	13
12	Precautions	14

1 Scope

1.1 Scope of parts

This specification applies to the WPZ0906AS1 assembled high current power inductor.

1.2 Scope of application

- 1) Voltage regulator modules (VRMs) for servers, microprocessors.
- 2) Multi-phase DC-DC buck circuit.

1.3 Operating and storage temperature

The part temperature (ambient + temp. rise) should not exceed 125 °C under worst case operating conditions. Circuit design, component placement, PCB trace size and thickness, airflow and other cooling provisions all affect the part temperature. Part temperature should be verified in the end application.

- 1) Operating temperature range (individual chip without packing)-40°C ~ +125°C (including self-heating).
- 2) Storage temperature range: -40°C~+85°C and 5~95%RH

2 Product Description and Identification (Part Number)

- 1) Description: WPZ0906AS1, assembled high current power inductor
- 2) Product Identification (Part Number)

WPZ	0906	A	S	1	R10	K	T	□□□
①	②	③	④	⑤	⑥	⑦	⑧	⑨
① Product Type		WPZ: Assembled high current power inductor						
② External Dimensions(LxW) [mm]		0906:9.4x6.2						
③ Height (mm)		A: 10.1Max						
④ Feature type		S: Low Core Loss						
⑤ Quantity of Windings		1: One winding						
⑥ Nominal Inductance		Example: R10: 100nH,						
⑦ Inductance Tolerance		K: ±10%						
⑧ Packing		T: Tape & Reel						
⑨ Special Process code		Special Number to Follow the Order						

3 Shape and Dimensions

Dimensions and recommended PCB pattern for reflow soldering, refer to Fig.3-1 and Table 3-1.

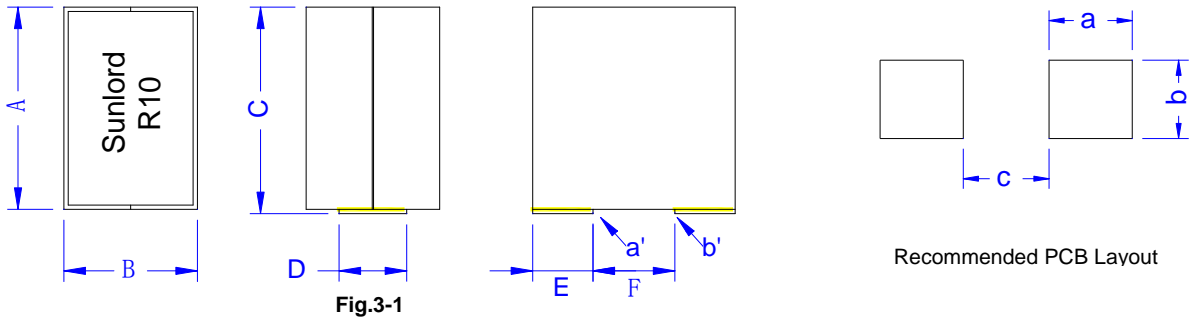
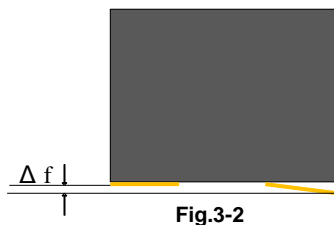

Table 3-1 (Unit: mm)

Series	A	B	C	D	E	F	a	b	c
WPZ0906AS170NKT	9.40±0.20	6.20±0.40	10.1Max.	3.15±0.20	2.80±0.20	3.80 Typ	3.30 Typ.	3.60 Typ.	3.40 Typ.
WPZ0906AS1R10KT									
WPZ0906AS1R12KT	9.40±0.20	6.20±0.20	10.1Max.	3.15±0.20	2.80±0.20	3.80 Typ	3.30 Typ.	3.60 Typ.	3.40 Typ
WPZ0906AS1R15KT									
WPZ0906AS1R18KT									
WPZ0906AS1R22KT									
WPZ0906AS1R28KT									



Δf: Clearance between terminal and the surface of plate must be 0.1mm Max. when coil is placed on a flat plate. (Refer to Fig.3-2)

4 Electrical Characteristics

Part Number	Inductance @100kHz/0.1V	DC Resistance @20°C	Saturation Current		Heat Rating Current (ΔT=40°C)
Units	nH	mΩ	A		A
Symbol	OCL	DCR	Isat1 @25°C	Isat2 @100°C	Irms
WPZ0906AS170NKT	70±10%	0.12 Max. (0.10 Typ.)	120	104	84
WPZ0906AS1R10KT	100±10%		93	74	
WPZ0906AS1R12KT	120±10%		70	60	
WPZ0906AS1R15KT	150±10%		55	48	
WPZ0906AS1R18KT	180±10%		46	40	
WPZ0906AS1R22KT	220±10%		38	33	
WPZ0906AS1R28KT	280±10%		30	26	

Note:

- ※ Open circuit inductance (OCL) test parameters: 100kHz, 0.1Vrms, 0.0A_{dc}
- ※ Isat1: Peak current for approximately 20% rolloff @ 25° C.
- ※ Isat2: Peak current for approximately 20% rolloff @ 100° C.
- ※ Irms: DC current that causes the temperature rise (ΔT) from 25°C ambient when two coils connected in series, ΔT is approximate 40°C.
- ※ Nominal DCR is measured from point a' to point b'. (refer to Fig. 3-1)

The part temperature (ambient + temp. rise) should not exceed 125 °C under worst case operating conditions. Circuit design, component placement, PCB trace size and thickness, airflow and other cooling provisions all affect the part temperature. Part temperature should be verified in the end application.

5 Test and Measurement Procedures

5.1 Test Conditions

- 5.1.1 Unless otherwise specified, the standard atmospheric conditions for measurement/test as:
 - 1) Ambient Temperature: 20±15℃
 - 2) Relative Humidity: 65±20%
 - 3) Air Pressure: 86kPa to 106kPa
- 5.1.2 If any doubt on the results, measurements/tests should be made within the following limits:
 - 1) Ambient Temperature: 20±2℃
 - 2) Relative Humidity: 65±5%
 - 3) Air Pressure: 86kPa to 106kPa

5.2 Visual Examination

Inspection Equipment: Visual

5.3 Electrical Test

- 5.3.1 Inductance (L)
 - 1) Refer to Item 4 Test equipment: WK3260B LCR meter or equivalent.
 - 2) Test Frequency and Voltage: refer to Item 4.
- 5.3.2 Direct Current Resistance (DCR)
 - 1) Refer to Item 4.
 - 2) Test equipment: HIOKI 3540 or equivalent.
- 5.3.3 Saturation Current (Isat)
 - 1) Refer to Item 4.
 - 2) Test equipment: WK3260B LCR meter or equivalent.
- 5.3.4 Temperature rise current (Irms)
 - 1) Refer to Item 4.
 - 2) Test equipment (refer to Fig. 5.3.4-1, Fig.5.3.4-2): Electric Power, Electric current meter, Thermometer.
 - 3) Measurement method
 - a) Set test current to be 0 mA.
 - b) Measure initial temperature of choke surface.
 - c) Gradually increase current and measure choke temperature for corresponding current.
 - d) Definition of Temperature rise current: DC current that causes the temperature rise (ΔT) from ambient temperature.

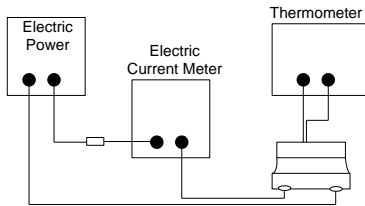

Fig. 5.3.4-1

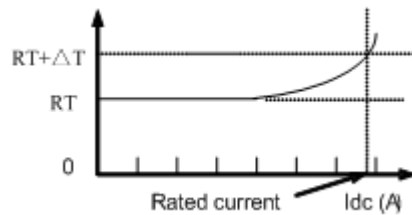

Fig. 5.3.4-2

6 Structure and material list

The structure of WPZ0906AS1 product, refer to Fig.6-1 and Table 6-1.

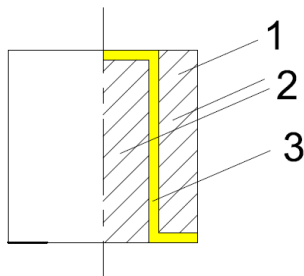

Fig.6-1

Note: 1. Clip material is C1100, 1/2H
 Plating layer, 2.54 um > Ni > 1.27um, 8um > Sn > 4 um.

No	Components	Material
1	Ferrite Core	Mn/Zn Ferrite
2	Resin	Epoxy
3	Clip	Cu/Ni/ Sn

Table.6-1

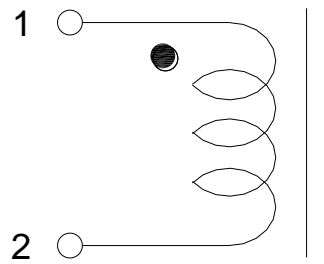

Fig.6-2 Schematic

7 Product Marking

The product marking, please refer to Fig.7-1.

R10: Inductance of the products.



Fig.7-1

8 Reliability Test

No	Test Items	Samples Quantity (pcs)	Test Condition	Reference	Acceptance Criteria
1	Preconditioning	475	Step 1, Initial electrical test Step 2, Temperature Cycling (-40 +0/-10) °C to (60 +10/-0)°C, 5 cycles, 10min cold zone and 10 min hot zone for each cycle Step 3, Bake out:125 +5-0°C, 24hrs Step 4, Moisture Soak: 85°C, 85% RH, 168+5/-0 hours Step 5, Reflow: 260 +0/-5°C, 3 cycles (Devices should be soldered on board)	JESD22 Method A113	1. Inductance & DCR change rate <± 10% 2. Appearance has no damage
2	Temperature Characteristics	30	1. Preconditioning is required. 2. Measure the characters at -40°C and 125°C after samples stabilized 3. Compare the characters at normal temperature.	Specification	1. Inductance & DCR change rate <± 10% 2. Appearance has no damage
3	High Temperature Storage	77	1. Preconditioning is requirement 2. +125 °C±2°C,1000hrs 3. Measurements shall be taken at room temperature within 24 hours	MIL-STD-202 Method 108	1. Inductance & DCR change rate <± 10% 2. Appearance has no damage
4	Low Temperature Storage	77	1. Preconditioning is required. 2. -40°C±2°C,1000hrs 3. Measurements shall be taken at room temperature within 24 hours	JESD22 Method A119	1. Inductance & DCR change rate <± 10% 2. Appearance has no damage
5	Temperature Cycling	77	1. Preconditioning is requirement 2. -40 °C / +125 °C, 1000 Cycles, 30 Minutes @ each extreme 3. Measurements shall be taken at room temperature within 24 hours	JESD22 Method JA-104	1. Inductance & DCR change rate <± 10% 2. Appearance has no damage
6	High Temperature Humidity (Damp Heat - Steady State)	77	1. Preconditioning is required. 2. 85°C, 85%RH, 1000hrs. 3. Measurements shall be taken at room temperature within 24 hours	JESD22 Method A101	1. Inductance & DCR change rate <± 10% 2. Appearance has no damage
7	Operational Life	77	1. Preconditioning is required. 2. Rated current, 125°C (including self temperature rise), 1000hrs. 3. Measurements shall be taken at room temperature within 24 hours	JESD22 Method A108	1. Inductance & DCR change rate <± 10% 2. Appearance has no damage
8	Bending Strength	30	1. Preconditioning is required. 2. Solder the devices on a PCB 3. Bending speed is 1mm/s 4. Keeping the PCB 2 mm Min. for 60 seconds 5. Measurements shall be taken at room temperature within 24 hours	AEC-Q200 Method 005	1. Inductance & DCR change rate <± 10% 2. Appearance has no damage
9	Terminal Strength	30	1. Preconditioning is required. 2. With the component mounted on a PCB 3. Apply 18N force to the side of a device being tested. This force shall be applied for 60 +1 seconds. 4. Measurements shall be taken at room temperature within 24 hours	AEC-Q200 Method 006	1. Inductance & DCR change rate <± 10% 2. Appearance has no damage
10	Vibration	30	1. 3 times reflow preconditioning 2. Frequency range : 10~2000Hz 3. Amplitude: 1.5mm or 20 G 4. Sweep time and duration: 10~2000~10Hz for 20 minutes 5. Each four hours(12 times) in X,Y,Z direction: 12 hours in total	MIL-STD-202G Method 204D	1. Inductance & DCR change rate <± 10% 2. Appearance has no damage
11	Mechanical Shock	30	1. 3 times reflow preconditioning 2. 100G, 6 ms, half sine shocks	MIL-STD-202G Method 213	1. Inductance & DCR change rate <± 10% 2. Appearance has no damage
12	Resistance to Soldering Heat	30	DIP: 260+/-5°C, 10+/-1sec , 1 time, or IR Reflow: 250+5°C (component temp), 30 sec, 3 times	MIL-STD-202G Method 210F	1. Inductance & DCR change rate <± 10% 2. Appearance has no damage
13	Solderability	15	8 hours steam aging, or high temperature preconditioning at 155°C for 4 hours, solder temperature 245 °C ± 5 °C, 5 ± 0.5 s	J-STD-002-E	Soldering surface >95%

Note: Products after preconditioning are only for items #2 to items #9.

9 Packaging and Storage

9.1 Tape and Reel Packaging Dimensions

9.1.1 Tape specifications

1) Carrier tape dimensions (Refer to Fig. 9.1.1-1 and Table 9.1.1-1)

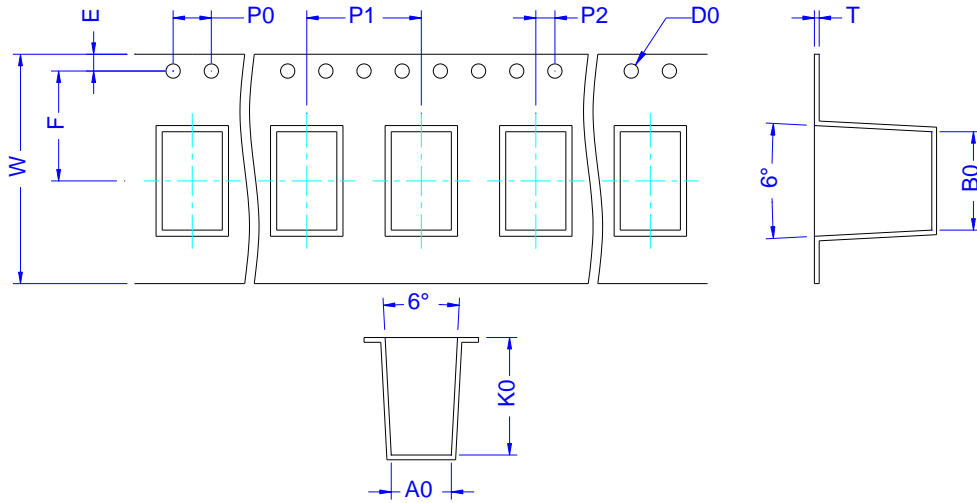

Fig. 9.1.1-1

Table.9.1.1-1

Series	W	E	F	P ₀	P ₁	P ₂	D ₀	A ₀	B ₀	T	K ₀
WPZ0906AS1	24.00 ± 0.30	1.75 ± 0.10	11.50 ± 0.10	4.0 ± 0.1	12.0 ± 0.1	2.0 ± 0.1	1.5 + 0.1/- 0.0	6.60 ± 0.10	10.0 ± 0.10	0.50 ± 0.05	10.3 ± 0.10

Note: the drawing of carrier tape is only to show the dimensions, the shape of cave maybe has difference with actual carrier tape.

2) Direction of rolling (Refer to Fig. 9.1.1-2)

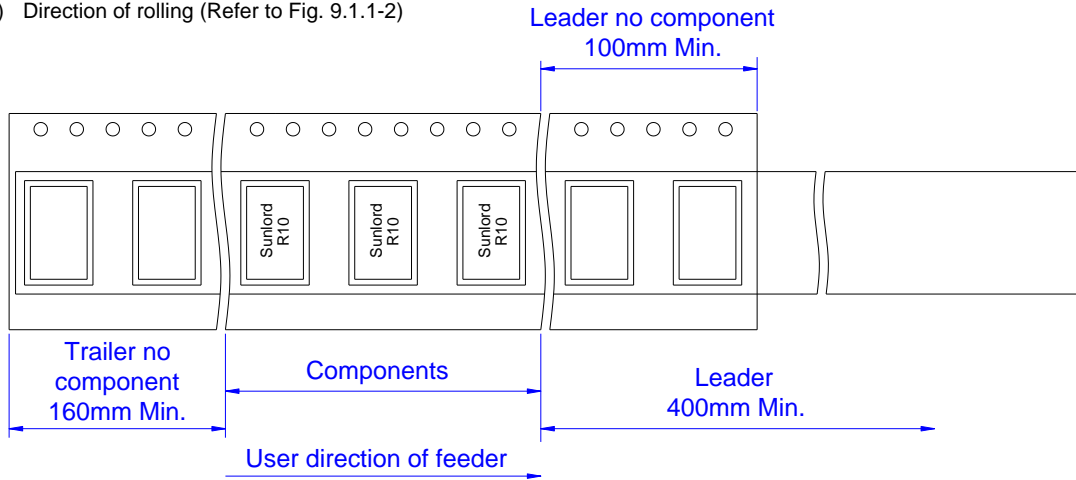

Fig. 9.1.1-2

SPQ: 400pcs/reel

MOQ: 2000pcs per carton

9.1.2 Reel Dimensions (Unit: mm)

Please refer to Fig. 9.1.2.

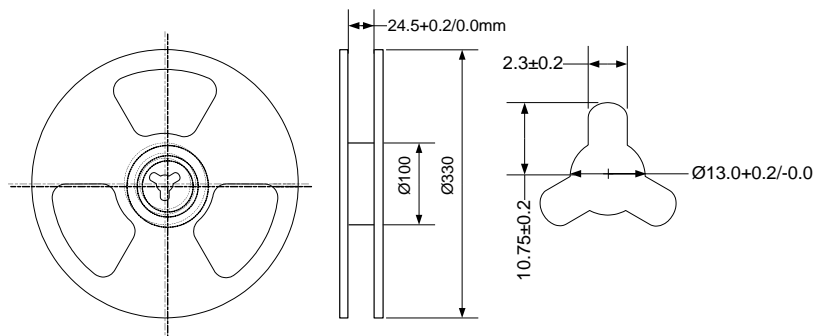

Fig.9.1.2

- 9.1.3 Top tape strength
 Peel-off strength: 10~150gf.
 Peel-off angle: 165°~180°, refer to Fig. 9.1.3.
 Peel-off speed: 300mm/min.

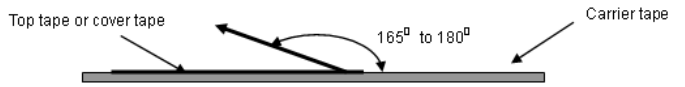

Fig. 9.1.3

- 9.1.4 The number of components
 A tape& reel package contains 400pcs inductors.
- 9.1.5 The allowable number of empty chip cavities: 0 chip.

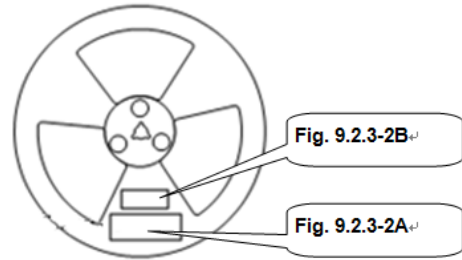

Fig. 9.2.3-1

9.2 Packing Documents and Marking

- 9.2.1 Packing Documents
 Packing documents include the following:

- 1) Packaging list
- 2) Certificate of compliance (COC)

9.2.2 Packing QTY.

- 1) Outer Box: 2 or 4 inner boxes in each outer case.

9.2.3 Marking

- 1) Marking label information on reels includes (Refer to Fig. 9.2.3-1、 Fig. 9.2.3-2A/2B):

Fig.9.2.3-2A: Shipping labels

- a) P/O No.
- b) Customer Part No.
- c) Sunlord Part No.
- d) Quantity.
- e) Lot No.
- f) Date code.
- g) Inspection stamp.
- h) MFG address as 'Made in China'.

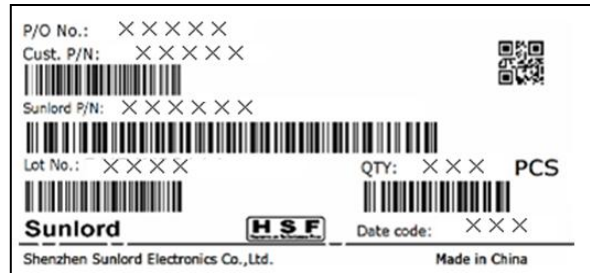

Fig.9.2.3-2A

- 2) Fig.9.2.3-2B: Production labels

- a) P/O No.
- b) Quantity.
- c) Lot No.
- d) Inspe No.
- e) Inspection stamp.
- f) MFG address as 'Made in China'.
- g) Sequence number.

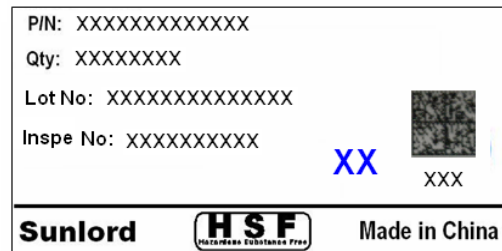

Fig.9.2.3-2B

- 3) Marking on outer case (Refer to Fig.9.2.3-3~5):

Out case size please refer to Table 9.2.3-1.

- a) Manufacturer: Sunlord ID:
- b) "Shenzhen Sunlord Electronics Co., Ltd."
- c) Packing label include the following:
 - i. Customer.
 - ii. Manufacturer.
 - iii. Date code.
 - iv. C/No.

Example: "1/10" means that this case is the 1st one of total 10 cases.

- i. P/O No.
- ii. Customer Part No.
- iii. Sunlord Part No.
- iv. Quantity.
- v. Inspection Stamp.

Packaging type	L(mm)	W(mm)	H(mm)
TPY1	380	380	250
TPY2	380	380	190

Tab. 9.2.3-1

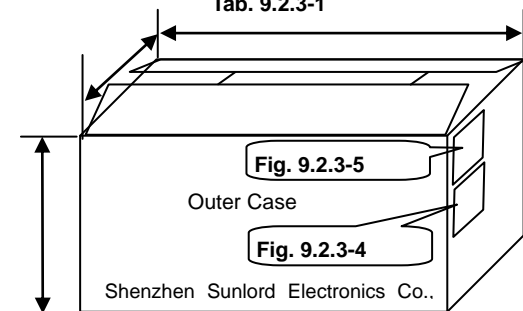

Fig. 9.2.3-3

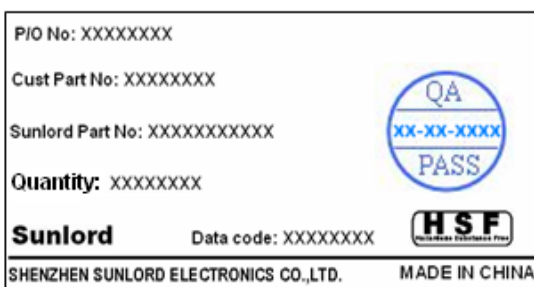

Fig.9.2.3-4

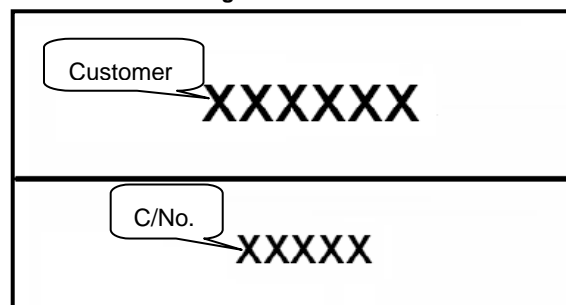

Fig.9.2.3-5

10 Visual inspection standard of product

File No:		Applied to assembled large current choke inductor Series		REV: 01
Effective date:				
No.	Defect Item	Graphic	Rejection identification	Acceptance
1	Core defect		The defect length/width (L and W) more than 2mm, NG.	AQL=0.65
2	Magnetic core cracking		Cracks visible to the naked eye is NG	AQL=0.65
3	Excessive glue		The defect length/width (L and W) more than 2mm, NG.	AQL=0.65
4	Magnetic core registration deviation		Size deviation (T) more than 0.2 mm, NG	AQL=0.65
5	Marking defect		1. The content of marking 1) is indistinct, 2) disagrees with current product P/N requirements, NG; 2. Intersection angle by L1 and L2 more than 45°, NG.	AQL=0.65

11 Recommended Soldering Technologies

11.1 Re-flowing Profile:

- 1) Preheat condition: 150 ~200°C/60~120sec.
- 2) Allowed time above 217°C: 60~90sec.
- 3) Max temp: 260°C
- 4) Max time at max temp: 5sec.
- 5) Solder paste: Sn/3.0Ag/0.5Cu
- 6) Allowed Reflow time: 3x max
- 7) Please refer to Fig. 11.1-1.

[Note: The reflow profile in the above table is only for qualification and is not meant to specify board assembly profiles. Actual board assembly profiles must be based on the customer's specific board design, solder paste and process, and should not exceed the parameters as the Reflow profile shows.]

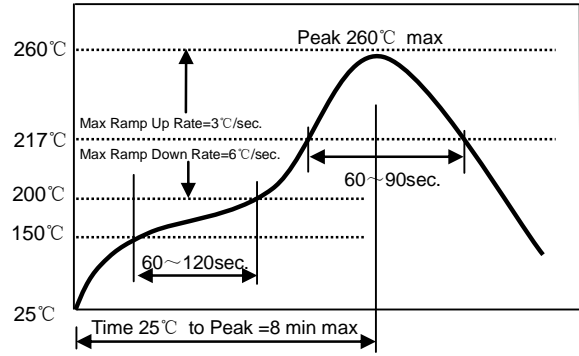

Fig. 11.1-1

11.2 Iron Soldering Profile

- 1) Iron soldering power: Max. 30W
- 2) Pre-heating: 150°C/60sec.
- 3) Soldering Tip temperature: 400°C Max.
- 4) Soldering time: 5secMin.
- 5) Solder paste: Sn/3.0Ag/0.5Cu
- 6) Max.1 times for iron soldering
- 7) Please refer to Fig. 11.2-1.

[Note: Take care not to apply the tip of the soldering iron to the terminal electrodes.]

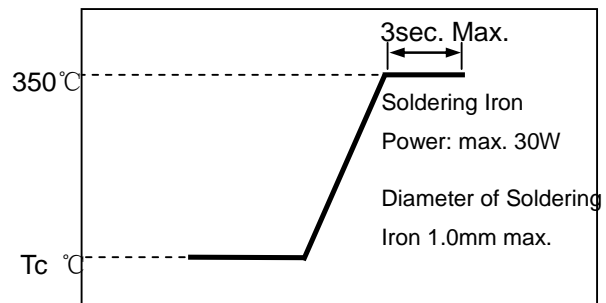

Fig. 11.2-1

12 Precautions

12.1 Surface mounting

- 1) Mounting and soldering condition should be checked beforehand.
- 2) Applicable soldering process to this product is reflow soldering only.
- 3) Recommended conditions for repair by soldering iron:
Preheat the circuit board with product to repair at 150°C for about 1 minute.
Put soldering iron on the land-pattern.
Soldering iron's temperature: 400°C maximum/Duration: 5seconds min/1 time for each terminal.
The soldering iron should not directly touch the inductor.
Product once removes from the circuit board may not be used again.

12.2 Handling

- 1) Keep the products away from all magnets and magnetic objects.
- 2) Be careful not to subject the products to excessive mechanical shocks.
- 3) Please avoid applying impact to the products after mounted on pc board.
- 4) Avoid ultrasonic cleaning.

12.3 Storage

- 1) To maintain the solder ability of terminal electrodes and to keep the packing material in good condition, temperature and humidity in the storage area should be controlled.
- 2) Recommended conditions: -40°C~125°C, 5~95%RH
- 3) Even under ideal storage conditions, solder ability of products electrodes may decrease as time passes. For this reason, product should be used with one year from the time of delivery.
- 4) In case of storage over 6 months, solder ability shall be checked before actual usage.

12.4 Regarding Regulations

- 1) Any Class- I or Class- II ozone-depleting substance (ODS) listed in the Clean Air Act in US for regulation is not included in the products or applied to the products at any stage of whose manufacturing processes.
- 2) Certain brominated flame retardants (PBBs, PBDEs) are not used at all.
- 3) The products of this specification are not subject to the Export Trade Control Order in China or the Export Administration Regulations in US.

12.5 Guarantee

- 1) The guaranteed operating conditions of the products are in accordance with the conditions specified in this specification.
- 2) Please note that Sunlord takes no responsibility for any failure and/or abnormality which is caused by use under other than the aforesaid operating conditions.