



### Features:

- Isolated mounting base 3000V~
- Pressure contact technology with increased power cycling capability
- Space and weight saving

### Typical Applications

- AC/DC Motor drives
- Various rectifiers
- DC supply for PWM inverter

$V_{RSM}$	$V_{RRM}$	Type & Outline
900V	800V	MDx182-08-216F3
1100V	1000V	MDx182-10-216F3
1300V	1200V	MDx182-12-216F3
1500V	1400V	MDx182-14-216F3
1700V	1600V	MDx182-16-216F3
1900V	1800V	MDx182-18-216F3

SYMBOL	CHARACTERISTIC	TEST CONDITIONS	$T_j(^{\circ}C)$	VALUE			UNIT
				Min	Type	Max	
$I_{F(AV)}$	Mean forward current	180° half sine wave 50Hz Single side cooled, $T_c=100^{\circ}C$	150			182	A
$I_{F(RMS)}$	RMS forward current		150			286	A
$I_{RRM}$	Repetitive peak current	at $V_{RRM}$	150			12	mA
$I_{FSM}$	Surge forward current	10ms half sine wave	150			6.4	KA
$I^2t$	$I^2T$ for fusing coordination	$V_R=0.6V_{RRM}$				205	$A^2s \cdot 10^3$
$V_{FO}$	Threshold voltage		150			0.80	V
$r_F$	Forward slop resistance					0.96	m $\Omega$
$V_{FM}$	Peak forward voltage	$I_{FM}=550A$	25			1.43	V
$R_{th(j-c)}$	Thermal resistance Junction to case	At 180° sine Single side cooled per chip				0.220	$^{\circ}C/W$
$R_{th(c-h)}$	Thermal resistance case to heatsink	At 180° sine Single side cooled per chip				0.08	$^{\circ}C/W$
$V_{ISO}$	Isolation voltage	50Hz, R.M.S, t=1min, $I_{ISO}=1mA(max)$		3000			V
$F_m$	Terminal connection torque(M6)				6.0		N·m
	Mounting torque(M6)				6.0		N·m
$T_{stg}$	Stored temperature			-40		125	$^{\circ}C$
$W_t$	Weight				285		g
Outline	216F3						

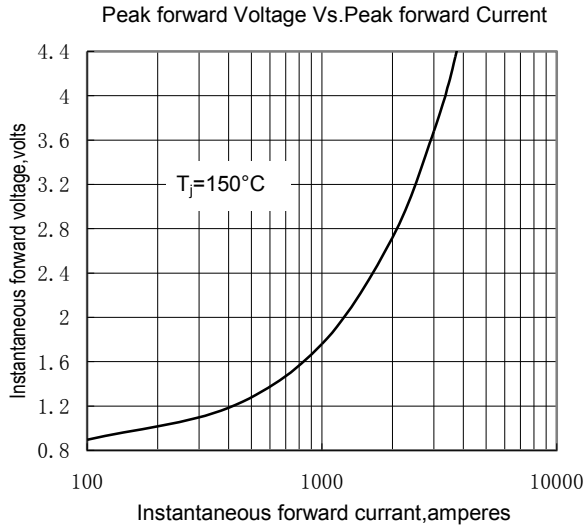

Fig.1

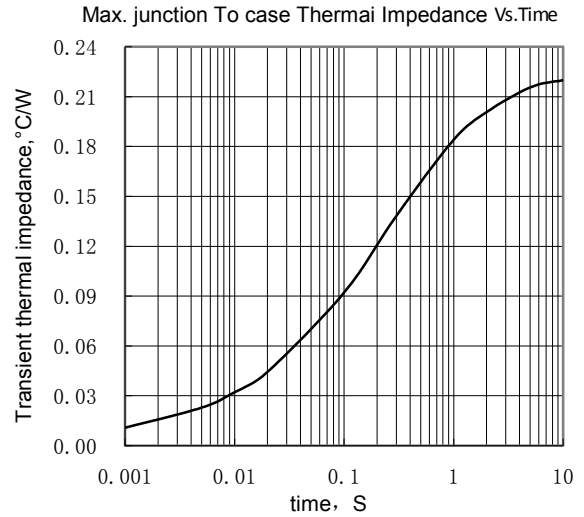

Fig.2

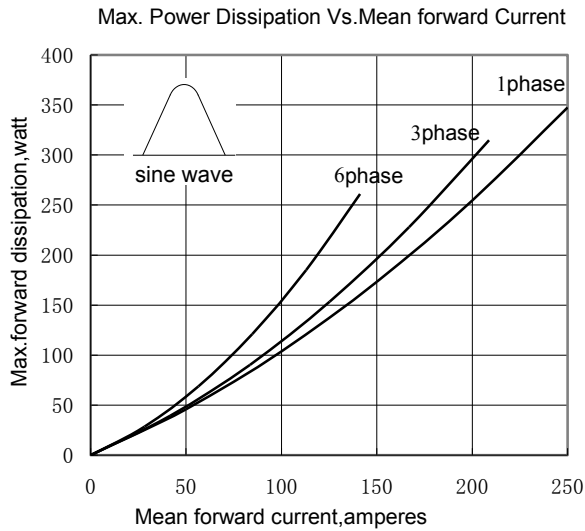

Fig.3

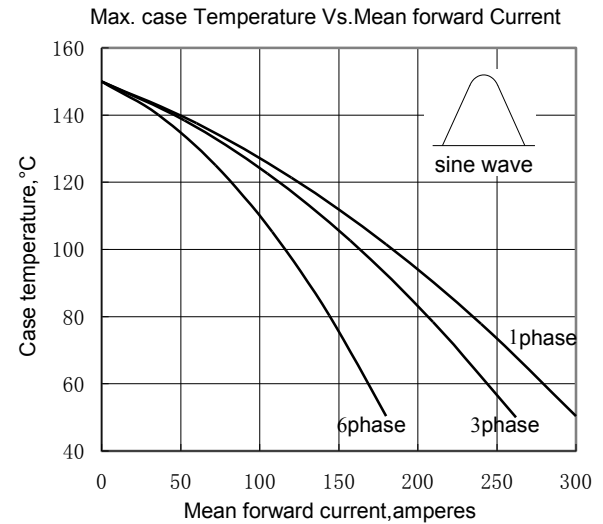

Fig.4

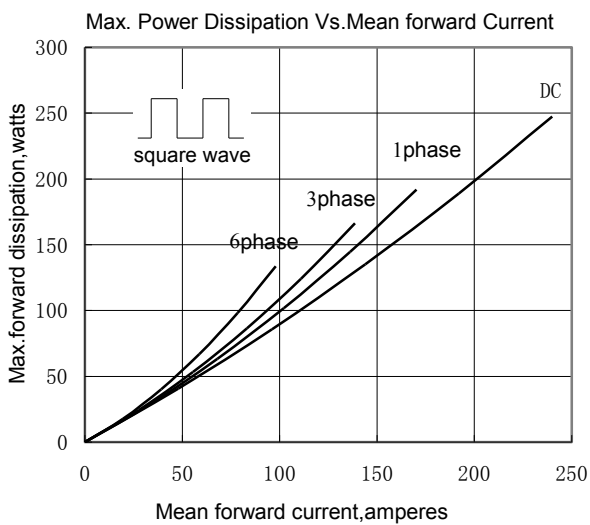

Fig.5

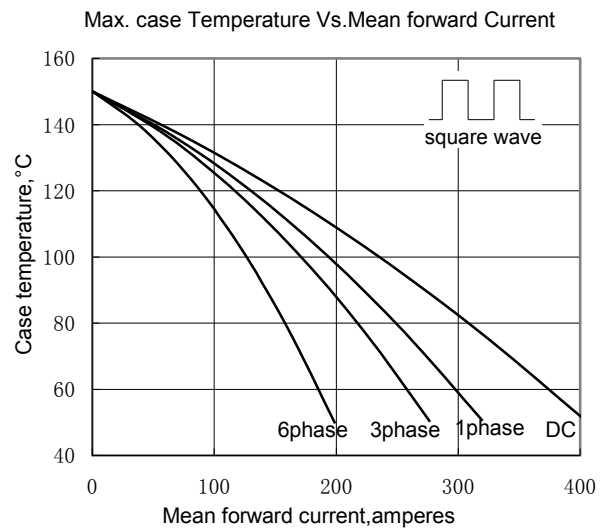
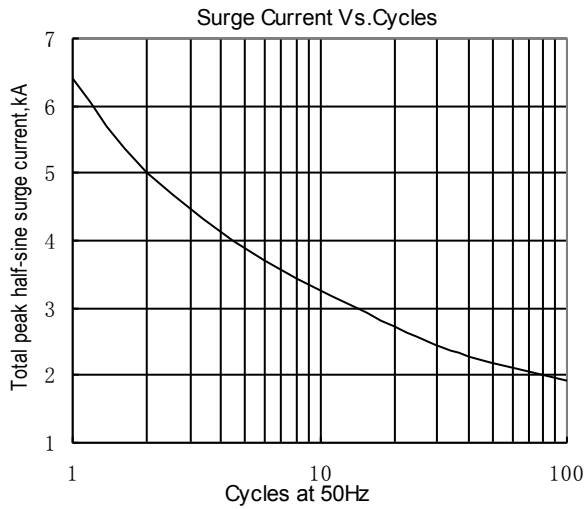
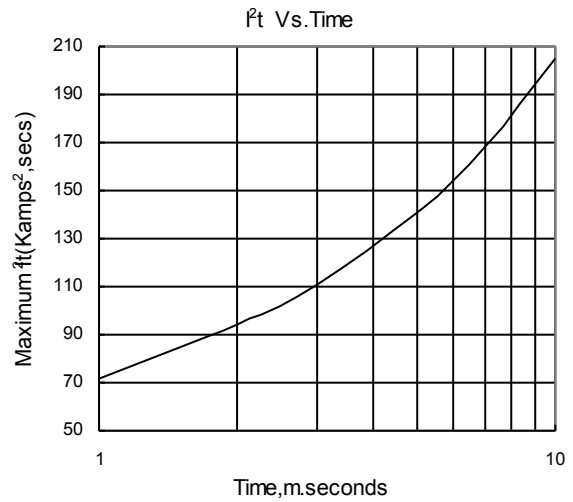

Fig.6

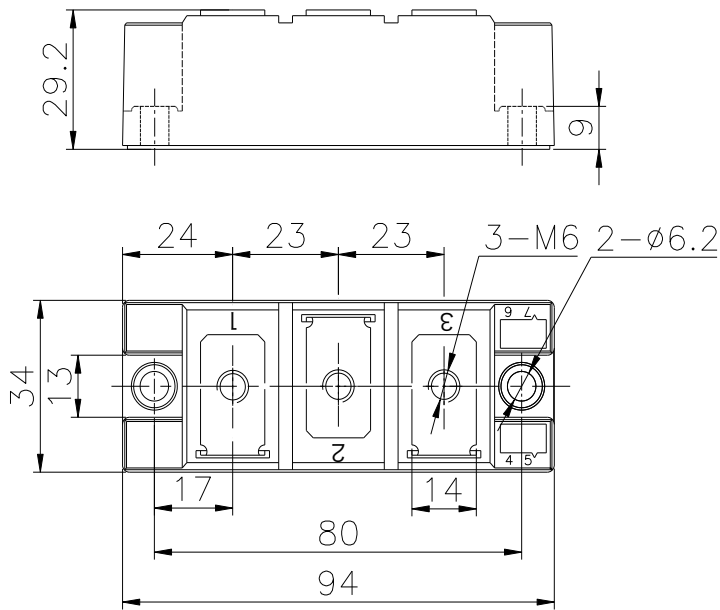

**Fig.7**



**Fig.8**

**Outline:**



**216F3**

