



Features:

- Isolated mounting base 3000V~
- Pressure contact technology with increased power cycling capability
- Space and weight saving

Typical Applications

- AC/DC Motor drives
- Various rectifiers
- DC supply for PWM inverter

V_{DSM}, V_{RSM}	V_{DRM}, V_{RRM}	Type & Outline
900V	800V	MFx285-08-413F3
1100V	1000V	MFx285-10-413F3
1300V	1200V	MFx285-12-413F3
1500V	1400V	MFx285-14-413F3
1700V	1600V	MFx285-16-413F3
1900V	1800V	MFx285-18-413F3

SYMBOL	CHARACTERISTIC	TEST CONDITIONS	$T_j(^{\circ}C)$	VALUE			UNIT
				Min	Type	Max	
$I_{T(AV)}$	Mean on-state current	180° half sine wave 50Hz Single side cooled, $T_c=85^{\circ}C$	125			285	A
$I_{T(RMS)}$	RMS on-state current		125			447	A
I_{DRM} I_{RRM}	Repetitive peak current	at V_{DRM} at V_{RRM}	125			25	mA
I_{TSM}	Surge on-state current	10ms half sine wave	125			9.1	KA
I^2t	I^2T for fusing coordination	$V_R=60\%V_{RRM}$				414	$A^2s \cdot 10^3$
V_{TO}	Threshold voltage		125			0.80	V
r_T	On-state slop resistance					0.53	mΩ
V_{TM}	Peak on-state voltage	$I_{TM}=750A$	25			1.45	V
dv/dt	Critical rate of rise of off-state voltage	$V_{DM}=67\%V_{DRM}$	125			1000	V/μs
di/dt	Critical rate of rise of on-state current	Gate source 1.5A $t_r \leq 0.5\mu s$ Repetitive	125			200	A/μs
I_{GT}	Gate trigger current		25	30		180	mA
V_{GT}	Gate trigger voltage	$V_A=12V, I_A=1A$		1.0		2.5	V
I_H	Holding current			20		180	mA
V_{GD}	Non-trigger gate voltage	$V_{DM}=67\%V_{DRM}$	125	0.2			V
$R_{th(j-c)}$	Thermal resistance Junction to case	Single side cooled				0.120	$^{\circ}C/W$
$R_{th(c-h)}$	Thermal resistance case to heatsink	Single side cooled				0.04	$^{\circ}C/W$
V_{iso}	Isolation voltage	50Hz, R.M.S, $t=1min, I_{iso}:1mA(MAX)$		3000			V
F_m	Thermal connection torque(M8)				12.0		N·m
	Mounting torque(M6)				6.0		N·m
T_{stg}	Stored temperature			-40		125	$^{\circ}C$
W_t	Weight				820		g
Outline	413F3D						

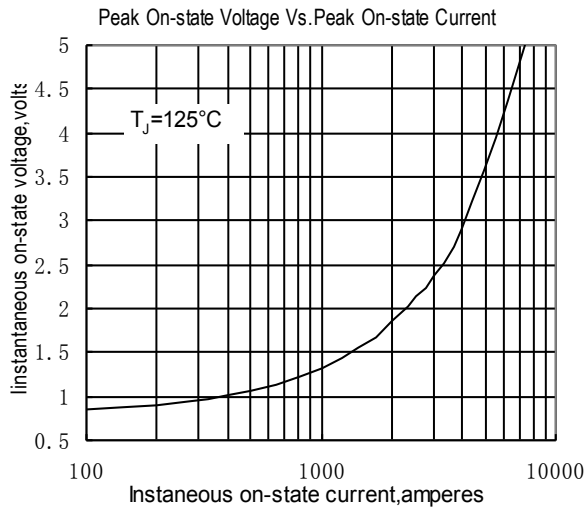

Fig.1

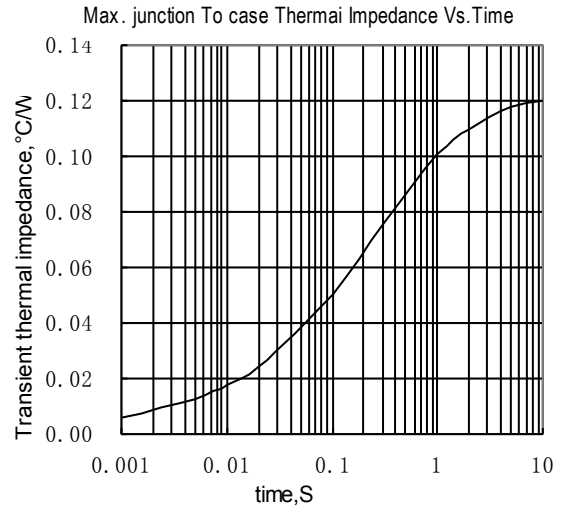

Fig.2

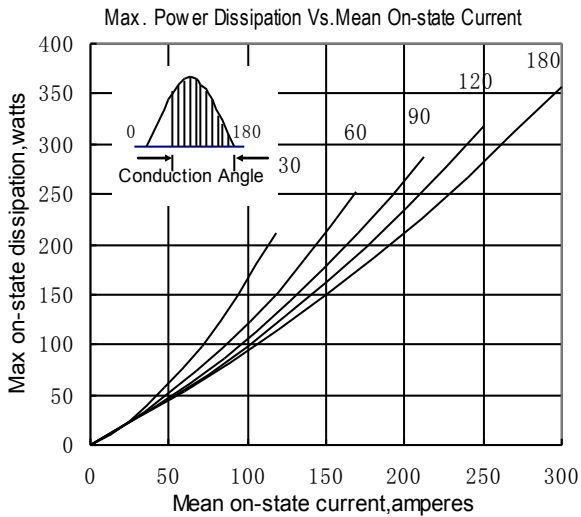

Fig.3

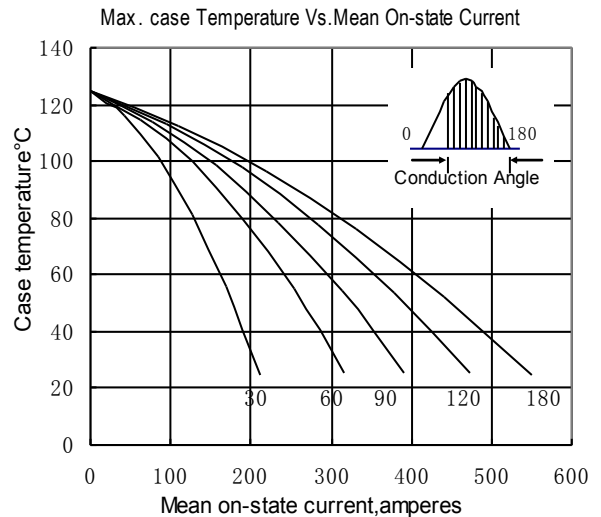

Fig.4

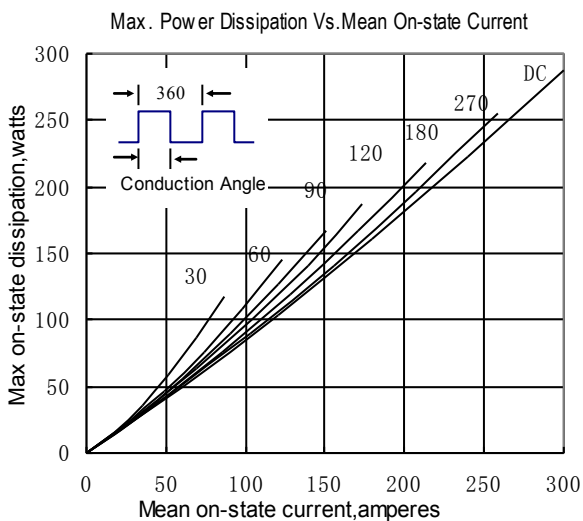

Fig.5

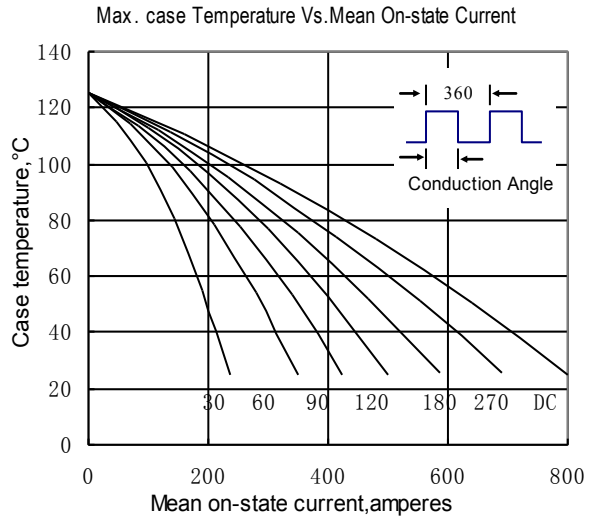

Fig.6

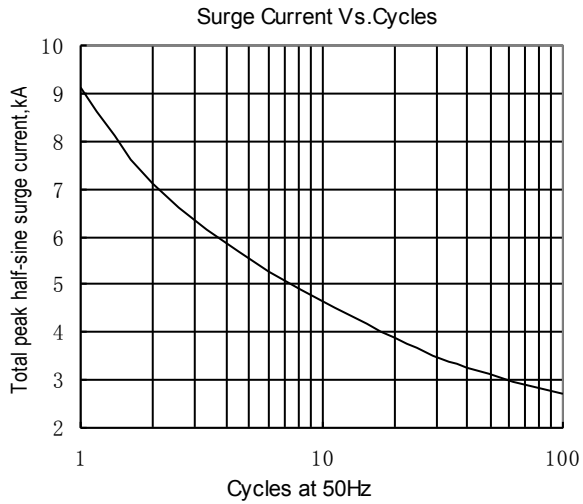

Fig.7

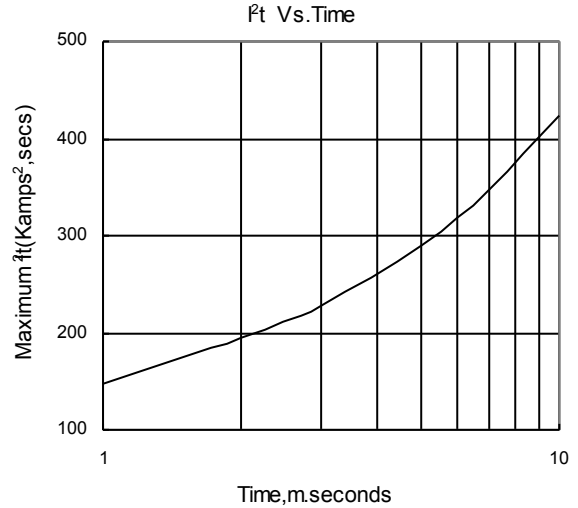

Fig.8

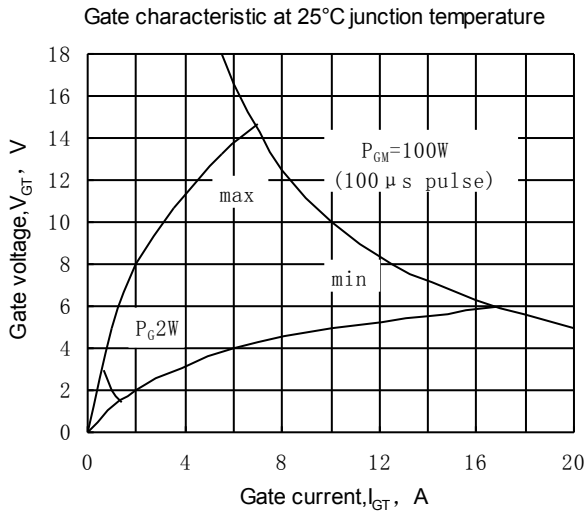

Fig.9

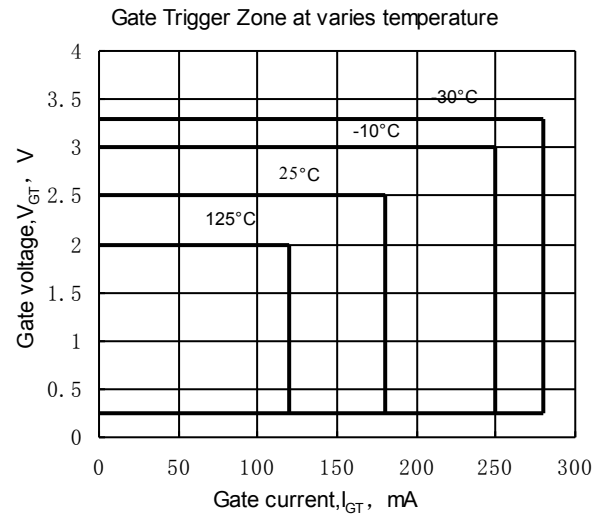
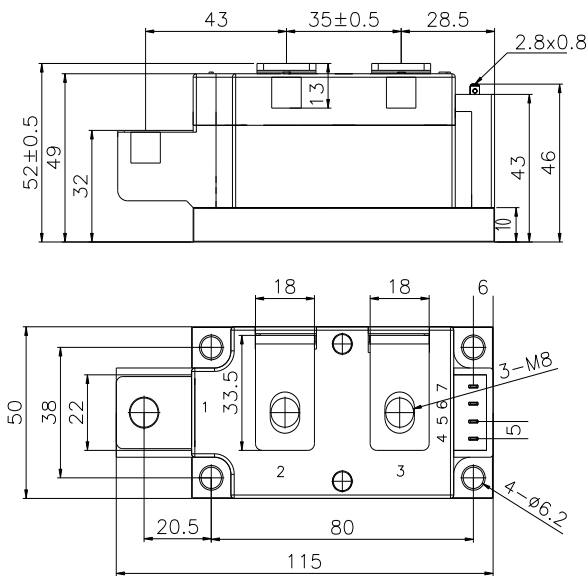

Fig.10

Outline:



413F3D

