

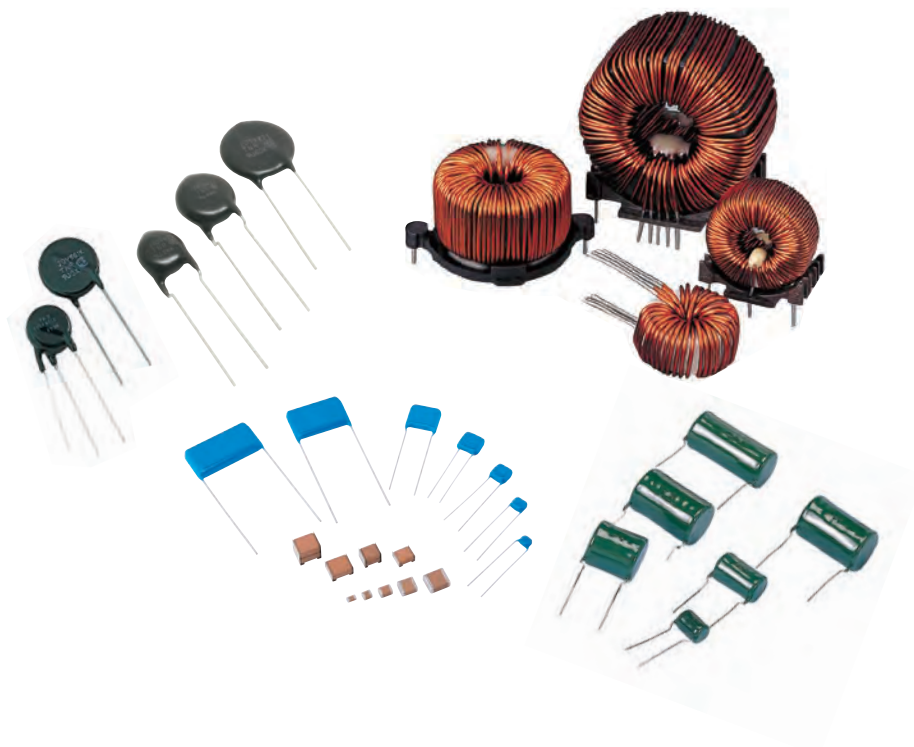

2023

CERAMIC CAPACITORS
VARISTORS
FILM CAPACITORS
CHOKE COILS

CAT.NO.E1002C / E1006F / E1003Z / E1008X



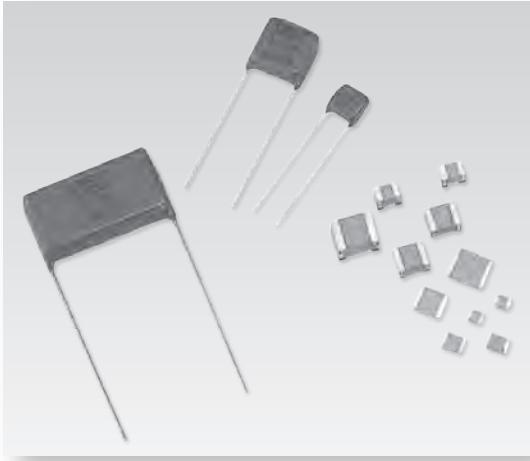

MULTILAYER CERAMIC CAPACITORS

Production Guide	P4-12
Series Table	P4
Part Numbering System	P5
Packaging	P6
Minimum Packaging Quantity	P7
Precautions and Guidelines	P8
Standardization	P12
Product Specifications	P13-31
NTS Series / NTF Series	P13
KVF Series	P19
NTJ Series	P22
KVJ Series	P25
NTD Series	P28
KVD Series	P32
Characteristics Data	P35-37



Item	Series	Rated Voltage Range (Vdc)	Rated Capacitance Range(μF)	Temperature Characteristics	RoHS2 Compliant	Page
Chip Type	NTS	25 to 500	0.010 to 47	X7R : -55~+125°C ΔC/C 25°C=±15%	Compliant	13
Chip Type	NTF	25 to 500	0.033 to 33	X7S : -55~+125°C ΔC/C 25°C=±22%		13
Chip Type	KVF	25 to 100	0.033 to 15	X8L : -55~+125°C ΔC/C 25°C=±15% +125~+150°C ΔC/C 25°C=+15%, -40%		19
Metal cap Type	NTJ	25 to 250	1.0 to 100	X7R : -55~+125°C ΔC/C 25°C=±15%		22
Metal cap Type	KVJ	25 to 100	0.68 to 22	X8L : -55~+125°C ΔC/C 25°C=±15% +125~+150°C ΔC/C 25°C=+15%, -40%		25
Lead Type	NTD	25 to 500	0.1 to 470	X7R : -55~+125°C ΔC/C 25°C=±15%		28
Lead Type	KVD	25 to 100	0.1 to 15	X8L : -55~+125°C ΔC/C 25°C=±15% +125~+150°C ΔC/C 25°C=+15%, -40%		32

Part Numbering System

◆ PART NUMBERING SYSTEM (CHIP TYPE)

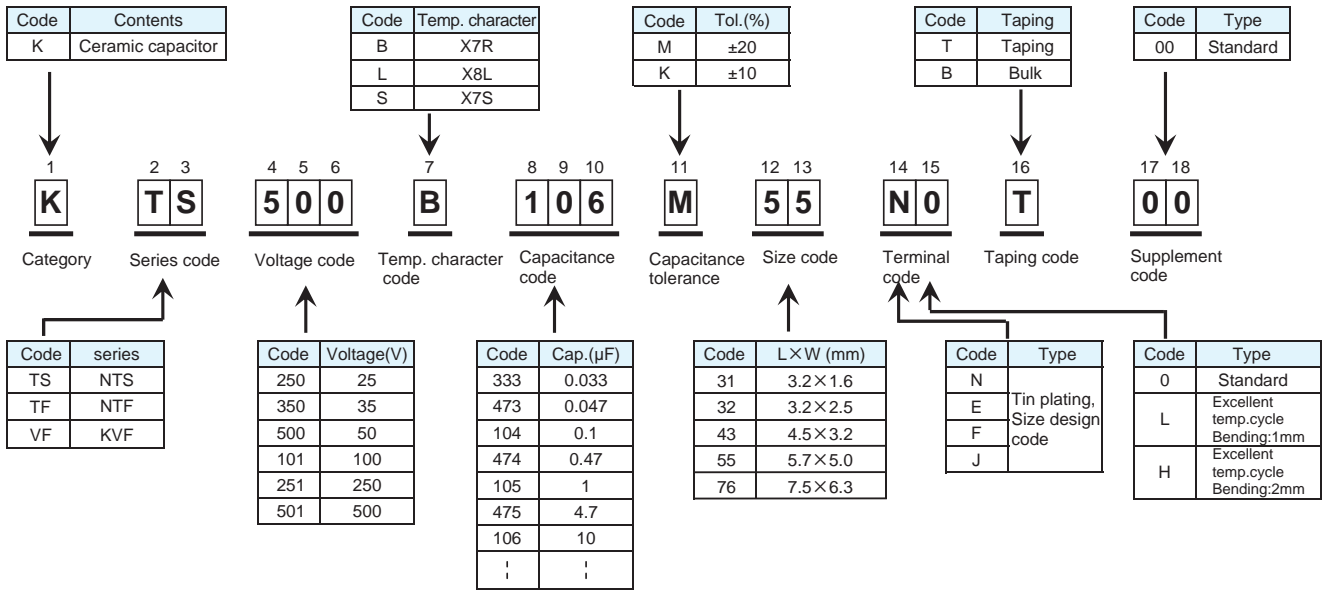

◆ PART NUMBERING SYSTEM (METAL CAP)

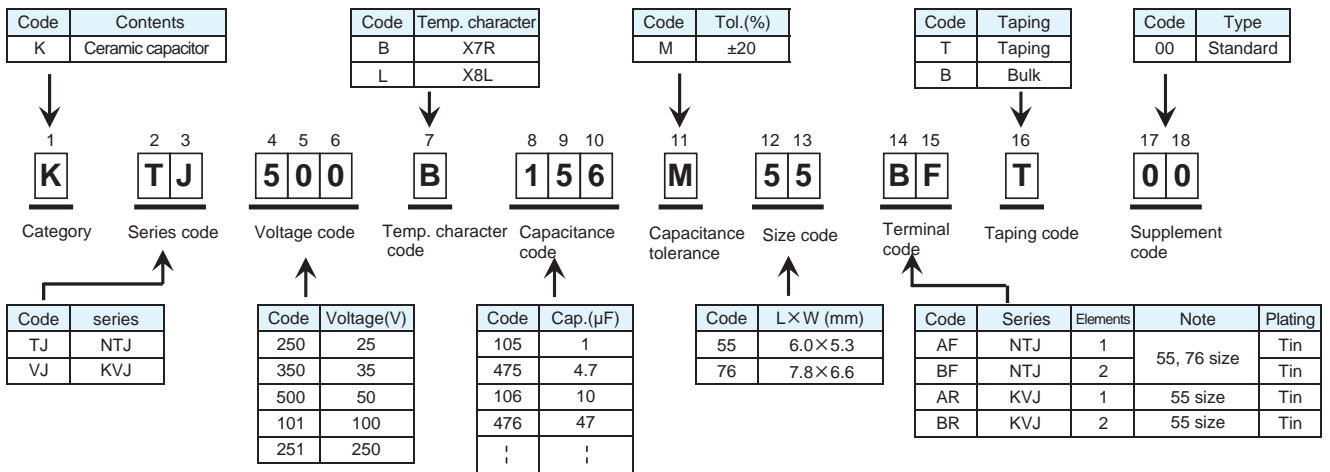

◆ PART NUMBERING SYSTEM (RADIAL LEAD TYPE)

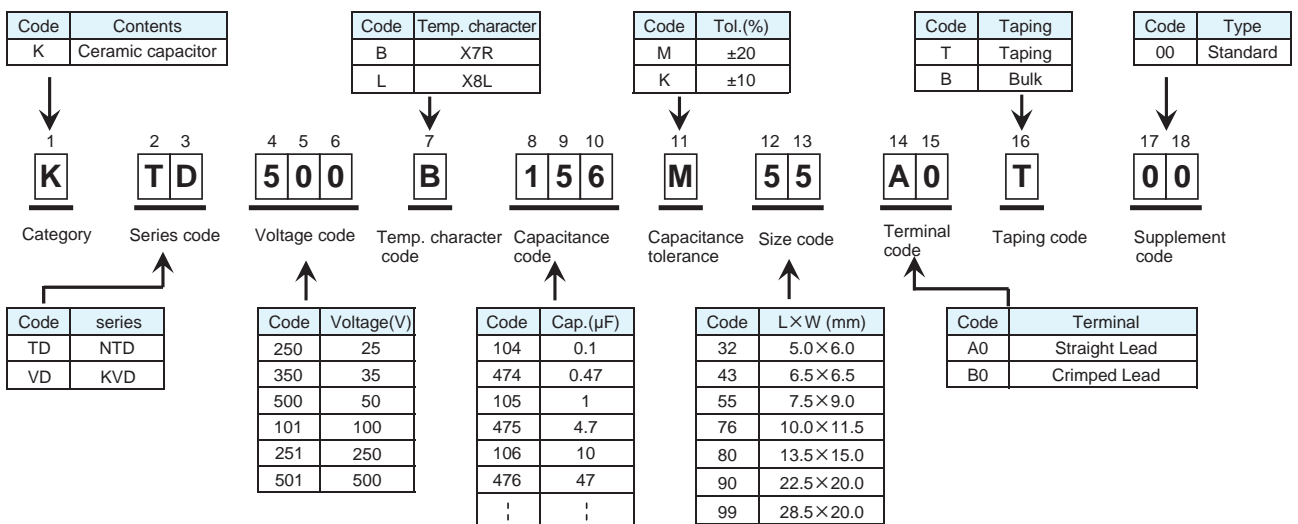

◆CHIP TYPE TAPING SPECIFICATION

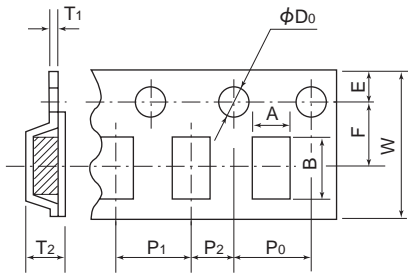

Type	Size Code	Dimensions (mm)										
		A*	B*	W ±0.3	F ±0.05	E ±0.1	P1 ±0.1	P2 ±0.05	P0 ±0.1	ϕD ±0.1	T1 max.	T2 max.
Chip type	31	1.9	3.5	8.0	3.5	1.75	4.0	2.0	4.0	1.5	0.6	1.5
	32	2.8	3.5	8.0	3.5	1.75	4.0	2.0	4.0	1.5	0.6	2.5
	43	3.65	4.95	12.0	5.5	1.75	8.0	2.0	4.0	1.5	0.6	3.5
	55	5.5	6.25	12.0	5.5	1.75	8.0	2.0	4.0	1.5	0.6	3.5
	76	6.85	8.05	16.0	7.5	1.75	12.0	2.0	4.0	1.5	0.6	5.5
Metal cap type	55	5.3	6.4	16.0	7.5	1.75	8.0	2.0	4.0	1.5	0.6	6.0
	76	6.9	8.2	16.0	7.5	1.75	12.0	2.0	4.0	1.5	0.6	7.5
		6.9	8.2	24.0	11.5	1.75	24.0	2.0	4.0	1.5	0.4	8.5
		6.9	8.2	32.0	14.2	1.75	24.0	2.0	4.0	1.5	0.5	10.0

*Reference

●REEL SPECIFICATIONS

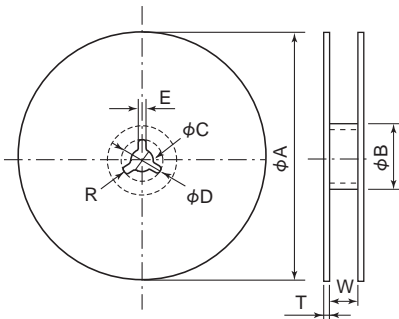

Size Code	Dimensions (mm)					
	NTS, NTF, KVF			NTJ, KVJ		
	31,32	43,55	76	55,76	76	
ϕA	180.0-3.0/+0	180.0-3.0/+0	180.0-3.0/+0	380.0±2.0	380.0±2.0	380.0±2.0
ϕB	60.0-0/+1.0	60.0-0/+1.0	60.0-0/+1.0	80.0±1.0	80.0±1.0	80.0±1.0
ϕC	13.0±0.2	13.0±0.2	13.0±0.2	13.0±0.2	13.0±0.2	13.0±0.2
ϕD	21.0±0.8	21.0±0.8	21.0±0.8	21.0±0.8	21.0±0.8	21.0±0.8
E	2.0±0.5	2.0±0.5	2.0±0.5	2.0±0.5	2.0±0.5	2.0±0.5
W	9.0-0/+1.0	13.0-0/+1.0	17.0-0/+1.0	17.4±1.0	25.4±1.0	33.4±1.0

NTS, NTF, KVF Series quantity per reel (pcs. / reel)

Size Code	31	32	43	55	76
Quantity	2000/3000	1600	800	800	300/500

Note : Refer to STANDARD RATINGS

NTJ, KVJ Series quantity per reel (pcs. / reel)

Size Code	55	76
Quantity	400/1500/2000	400/500/1200

Note : Refer to STANDARD RATINGS

◆RADIAL LEAD TYPE TAPING SPECIFICATION

●NTD, KVD Series

Available for 32, 43, 55, 76 sizes. Ammo Packaging.

Size Code	Dimensions H (mm)		Quantity per Packing (pcs.)
	Straight lead	Crimped lead	
32	23max.	25max.	2000
43	24max.	26max.	
55	26max.	28max.	
76	29max.	30max.	1000/1500

Note : Refer to STANDARD RATINGS

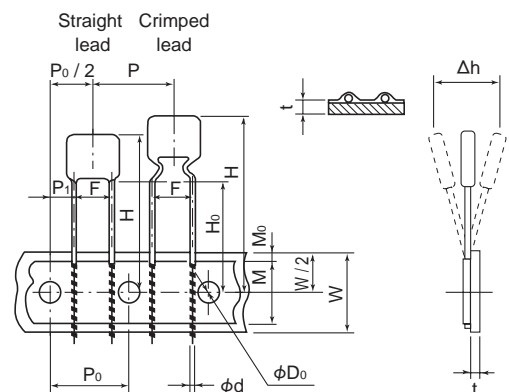

Code	P	P0	P1	P0/2	F	W	W/2	M	M0	H0	ϕD0	ϕd	t	Δh
Dimensions (mm)	12.7	12.7	3.85	6.35	5.0	18.0	9.0	13.0	1.5	16.0	4.0	0.5	0.6	0
	±1	±0.3	±0.7	±1.3	+0.8 -0.2	+1.0 -0.5	±0.5	±1	±1.5	min.	±0.2	±0.05	±0.2	±2

Minimum Packaging Quantity

Please order by units of minimum packaging quantity.

◆ Chip

Series	Size code	Elements	Rated voltage (V _{dc})	Rated Capacitance (μF)	Taping (pcs.)	Tray (pcs. / box)	Bagged (pcs. / box)
NTS, NTF, KVF	31	-	25	3.3	2,000	-	6,000
			50	1.5	2,000	-	6,000
			50	2.2	2,000	-	6,000
			100	1.0	2,000	-	6,000
			100	1.5	2,000	-	6,000
			100	2.2	2,000	-	6,000
	Rating other than the above			3,000		-	9,000
	32	-	All Voltage Range		1,600	-	6,000
43	-	All Voltage Range		800	-	3,000	
55	-	All Voltage Range		800	-	1,500	
NTS	76	-	500	0.68	500	-	1,500
			Rating other than the above		300	-	1,500

◆ Metal Cap

Series	Size code	Elements	Rated voltage (V _{dc})	Rated Capacitance (μF)	Taping (pcs.)	Tray (pcs. / box)	Bagged (pcs. / box)
NTJ, KVJ	55	1	All Voltage Range		400	800	-
		2	25	68	1,500	700	-
			50	33	1,500	700	-
			Rating other than the above		2,000	800	-
	76	1	All Voltage Range		1,200	800	-
		2	25	100	400	600	-
			50	33	500	700	-
			100	10	500	700	-
			All rating other than the above		500	600	-

◆ Radial Lead

Series	Size code	Elements	Rated voltage (V _{dc})	Rated Capacitance (μF)	Taping (pcs.)	Tray (pcs. / box)	Bagged (pcs. / box)
NTD, KVD	32	-	All Voltage Range		2,000	-	2,000
	43	-	All Voltage Range		2,000	-	2,000
	55	-	All Voltage Range		2,000	-	2,000
	76	-	500	0.68	1,500	-	500
			500	1.0	1,500	-	500
			500	1.2	1,500	-	500
			Rating other than the above		1,000	-	500
	80	-	All Voltage Range		-	100	-
	90	-	All Voltage Range		-	60	-
	99	-	All Voltage Range		-	50	-

The circuits described as examples in this catalog and the "delivery specifications" are featured in order to show the operations and usage of our products, however, this fact does not guarantee that the circuits are available to function in your equipment systems.

We are not in any case responsible for any failures or damage caused by the use of information contained herein.

You should examine our products, of which the characteristics are described in the "delivery specifications" and other documents, and determine whether or not our products suit your requirements according to the specifications of your equipment systems. Therefore, you bear final responsibility regarding the use of our products.

Please make sure that you take appropriate safety measures such as use of redundant design and malfunction prevention measures in order to prevent fatal accidents and/or fires in the event any of our products malfunction.

1 In designing device circuits

- (1) Confirming the installation and operating environment of capacitors, use them within the rated performance limits prescribed in their catalog or product specifications. Otherwise, excessive use conditions cause the capacitors to have catastrophic failure such as short circuit, open circuit or firing.
 - (2) Do not apply a DC voltage which exceeds the full rated voltage. The peak voltage of a superimposed AC voltage (ripple voltage) on the DC voltage must not exceed the full rated voltage.
 - (3) By considering the temperature characteristic and the DC bias characteristic of the ceramic capacitors, please determine the right capacitance. The capacitance of the capacitors changes in low and high temperature ambiances and depends on the applied bias voltages. The capacitance change (i.e. reduction) may affect the performance of the circuit which is containing the capacitors. Therefore, please examine the capacitors in the actual operational conditions to verify that they are right ones.
 - (4) The common failure mode of multilayer ceramic capacitors is contingent insulation breakdown or short circuit. When the capacitors are used in a high-power circuit, they may damage the surroundings of the capacitors when failed. Therefore, the high-power circuit should have protective device/protective devices to shut down the circuit from the capacitor/capacitors. The reliability of the capacitors improves when the ambient temperatures are in the normal temperature range and the applied voltages are low.
 - (5) When large high frequency ripple current acrosses multilayer ceramic capacitor, the capacitor can vibrate. The phenomenon occurs as the capacitor, has natural vibration frequency due to the mechanical dimensions, resonates to the large high frequency ripple current.
To prevent the resonance, please select the capacitor or change the ripple current frequency.
For your information, we indicate the following resonance frequency to each chip size.
- | Size Code | L × W (mm) | (kHz) |
|-----------|-------------|-----------------|
| 31 | 3.2 × 1.6 | 650, 1200, 1600 |
| 32 | 3.2 × 2.5 | 650, 850, 1200 |
| 43 | 4.5 × 3.2 | 450, 650, 1200 |
| 55 | 5.7 × 5.0 | 350, 450, 850 |
| 76 | 7.5 × 6.3 | 350, 600, 750 |
| 80 | 10.0 × 9.0 | 230, 320, 620 |
| 90 | 20.0 × 12.7 | 100, 170, 450 |
| 99 | 25.0 × 12.7 | 80, 160, 250 |
- (6) The capacitance of the capacitors depends on the ambient temperatures and bias voltages. Therefore, please examine the capacitors when they are to be used in a time-constant circuit before the use.
 - (7) Consult us for devices that requires high reliability. For components which are used to the devices whose failure affects human life or causes social loss by serious damage, higher reliable designs than general purpose components are required.
 - (8) Please contact us, when you use it for AC use.

2 In designing PC boards

- (1) Put the proper volume of solder (the size of fillet) on PC boards for installing surface mount capacitors, because it directly affects the installed capacitors. The design of copper pad patterns and dimensions should be set so that the proper volume of solder can be provided. The standard land dimensions are shown below.
- (2) Land width of PC boards shall not exceed the width of chip capacitors.

●Chip type (mm)

Code	Size Code	31	32	43	55	76
a		2.2 to 2.5	2.2 to 2.5	3.5 to 3.7	4.5 to 4.7	5.0 to 5.2
b		4.2 to 5.8	4.2 to 5.8	5.5 to 6.1	6.7 to 8.3	8.8 to 10.8
c		1.2 to 1.6	1.8 to 2.5	2.3 to 3.2	3.5 to 5.0	4.7 to 6.3
d		0.4 to 0.8	0.5 to 1.0	0.6 to 1.1	0.7 to 1.2	0.8 to 1.3

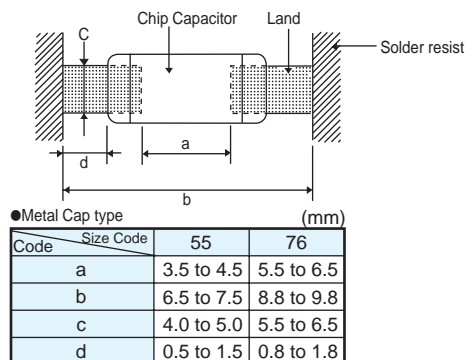

- (3) When the multilayer ceramic capacitors are mounted on a substrate, the chips may crack when mechanical stress is put. Also, when the substrate is bent, they may also crack. Therefore, please make sure that the material and size of the substrate and the capacitor positions are right.
- (4) For a leaded capacitor, design the PC boards with the correct terminal hole space equal to the lead space of the capacitor.

3 Installation

- (1) When installing leaded capacitors in the PC boards by means of an automatic insertion machine, minimize the mechanical shock applied to the capacitors by the lead clinch unit of the machine.
- (2) When the capacitors are to be mounted on a substrate, please minimize the shock and weight to the capacitor bodies. The nozzle pressure during the mounting process should be adjusted to 1N~3N maximum in static load.
- (3) Periodically maintain and inspect installation machines.
- (4) Where an adhesive is used to pre-anchor capacitors on PC boards, use appropriate copper pad dimensions, type of adhesive, coating volume, curing temperature and time, etc. to prevent the capacitors from deteriorating.

4 Soldering

- (1) Use flux with a halogen content of less than 0.1 wt. %. Do not use strong acid flux.
- (2) Minimize a volume of flux to coat the PC boards with.
- (3) Follow the soldering conditions prescribed in the catalog or product specifications. Excessive thermal stress affects the performance of the capacitors.
- (4) Note that surface mount capacitors with the size 3.2×1.6 or smaller tend to stand up during vapor phase reflow soldering.
- (5) For reflow soldering, place surface mount capacitors on the PC boards as soon as possible after solder paste was coated.
- (6) Please be aware that thermal deformation of substrates during mounting process cause stress to the substrates. Especially, substrates which are mounting chip capacitors are to be flow soldered to solder leaded parts or solder other parts onto the substrates, please make sure that the deformation during the soldering causes no harm. In fact, the deformation may cause stress to the substrates which leads to the capacitor element cracks/insulation-layer break down/insulation resistance degradation. The effect of the stress due to the deformation depends on the material of the substrates. Therefore, please be aware of the following information.
 - a) Ceramic substrates
The stress due to the deformation of ceramic substrates is thought to be the minimum. Heat contract difference during solder hardening can be the effect to ceramic capacitors mounted on the substrates. So, please avoid forced cooling during the hardening.
 - b) Glass epoxy substrates
The stress due to the deformation and warp of glass epoxy substrates affects ceramic capacitors mounted. The stress depends on the size and material of the substrates, pattern positions and thermal gradient during soldering. Temperature difference between the both sides of the substrates may also cause the stress. When the material of the substrates, which are mounting ceramic capacitors, is FR-4 or the equivalent and other parts are to be flow soldered, the surface of the side with the capacitors shall be sufficiently preheated to 150°C or over before the flow soldering. During the soldering, the temperature difference between the side with the capacitors and the other side of the substrate should be 100°C maximum.
 - c) Metal substrates
The deformation and warp of metal substrates considerably affect ceramic capacitors mounted. Therefore, please use metal caps which can moderate the stress of the substrates.
- (7) After reflow/flow soldering, please cool the PC boards which mounted capacitors naturally in the air.
- (8) Ceramic chip capacitors are solderable by twice maximum in reflow or flow soldering. When the capacitors are to be reflow soldered and then flow soldered, there shall be no additional soldering to the capacitors. However, the capacitors having a size of 5.7×5.0 or larger should be soldered by one time only.
- (9) Metal cap type capacitors (NTJ series) is two times reflow.
- (10) Due to the nature of ceramic, radical heating or cooling and partial heating may crack the ceramic capacitor element. Please have enough pre-heating process before soldering.
- (11) Ultrasonic cleaning time shall be ten minutes maximum.
When the power of ultrasonic cleaner is too high, the strength of terminations may drop.
Therefore, carefully examine the cleaning conditions before use.
- (12) Adjust the amount of solder cream in order that solder fillet shall be 1/2 to 2/3 height of chips. If fillet can confirm, size of 4.5×3.2 or larger is not this limit.
- (13) When more than two chips are mounted on a common land, please separate the chips by the solder resist.
- (14) In hand soldering, please take into consideration the following items.
 1. Fully pre-heat on a heating plate whose surface temperature is 100°C to 150°C .
 2. Soldering iron power shall not exceed 30W.
 3. Soldering iron tip diameter shall not exceed 3mm.
 4. Temperature of iron tip shall be adjusted to not exceed 300°C, 3sec.
 5. The soldering iron tip shall not touch ceramic body directly.
 6. After soldering, let the products to be room temperature to cool gradually.

5 Soldering profile

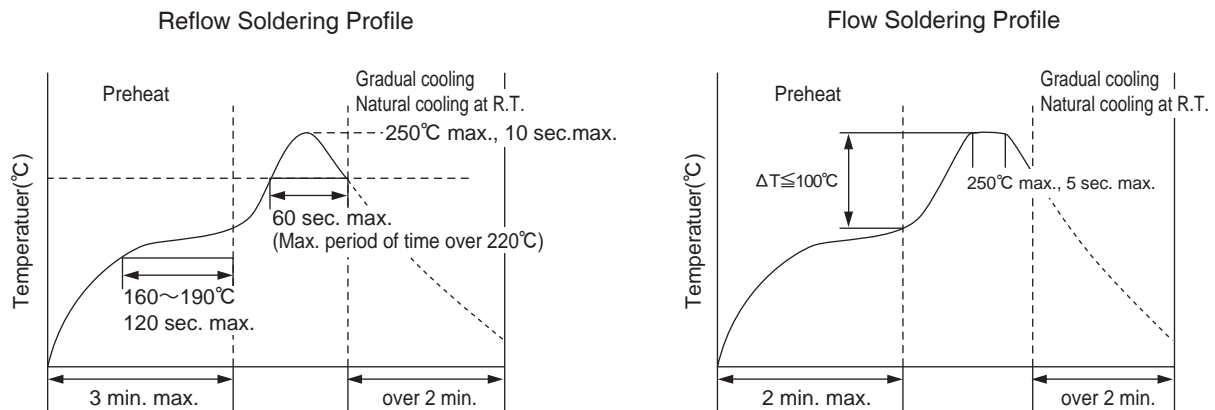

*Flow Soldering
Tin plating
(Size code : 31, 32, 43)

- (1) Do not expose the product to temperatures of 250°C or higher.

6 Cleaning

- (1) In the case that the assembly boards are washed, choose the appropriate cleaning agent for the washing purpose.
- (2) To determine the cleaning conditions, make sure by means of the actual washing equipment that the performance of the capacitors is not affected.
- (3) In the case that water-soluble flux was used, sufficiently wash the assembly boards.

7 Coating materials

- (1) When ceramic capacitors are to be resin coated or molded, please pay enough attention. Ceramic capacitors molded in resin, and please do not use it. There is fear to destroy a capacitor by stress to occur by the expansion / the shrinkage when resin stiffens. When a thermal expansion shrinkage coefficient in hardening uses big resin, coating in the resin which is soft with capacitors, please make that stress is added to capacitors small as much as possible.
- (2) Confirm that harmful resolution or formation gasses are not generated from the coating materials during the curing process or by spontaneously leaving the coated assembly boards.
- (3) If a coating material is cured at higher temperatures than the Category temperature of the capacitor, the exterior resin will deteriorate resulting in the capacitor damage.

8 Handling

- (1) When cutting off a multi-board to make individual units, curving or twisting the board may crack the capacitors. Appropriate tools should be used to cut it off.
- (2) Excessive mechanical shock to capacitors or their assembly boards may make the capacitors crack.
- (3) Use leaded capacitors without bending their lead wires as much as possible.
- (4) When ceramic capacitors are stored with no load, the capacitance reduces during the storage (named "aging characteristic"). As for the product that capacitance decreased, capacity recovers in an initial value by heat-treating it.
- (5) When the electrodes of the ceramic capacitors are made of silver, needle crystals may form on the electrodes in an ambience containing sulfur compounds.

9 Storage

- (1) Do not store and use capacitors in the following environment. Water or salt water splashes, dew wets or toxic gasses (hydrogen sulfide, sulfurous acid, chlorine, ammonium) fills, Vibration or mechanical shock exceeding the limits prescribed in the catalog or product specifications.
- (2) Do not store capacitors in places that direct sunlight pours down or dewy places.
- (3) Avoid high temperature and humidity.
The storage conditions should be : Temperature=Lower than 40°C
Humidity=Lower than 70% RH
- (4) The storage life is two years from the time of purchase as a general rule.



10 About AEC-Q200

The Automotive Electronics Council (AEC) was originally established by American major automotive manufactures. Today, the committees are composed of representatives from the sustaining Members of manufacturing companies in automotive electrical components. It has standardized the criteria for "stress test qualification" and "reliability test" for the electronic components.

AEC-Q200 is the reliability test standard for approval of passive components, it has been specified test subjects and quantity etc. for each components. Criteria of reliability tests such as our main products "Multilayer Ceramic Capacitors" are also described in this.

As customer requirement, Chemi-Con has submits the test results according to AEC-Q200 for the Multilayer Ceramic Capacitors used in automotive applications to increase in recent years.

AEC-Q200 compliant product is the product which we evaluated by AEC-Q200 standard.

Please contact us for more information.

Please obtain and verify our product specification sheet before you use our product.

11 Catalogs

Product specifications in this catalog are subject to change without notice.

Please request and make sure our product specifications before purchase and/or use.

12 Response to the Substances of Concern

(1) Nippon Chemi-Con aims for developing products that meet laws and regulations concerning substances of concern.

(Some products may contain regulated substances for exempted application.)

Please contact us for more information about law-compliance status.

(2) According to the content of REACH handbook (Guidance on requirements for substances in articles which is published on May 2008), our electronic components are "articles without any intended release". Therefore they are not applicable for "Registration" for EU REACH Regulation Article 7 (1).

Reference: Electrolytic Condenser Investigation Society

"Study of REACH Regulation in EU about Electrolytic Capacitor" (publicized on 13 March 2008)

For the details, refer to Guideline of notabilia for fixed multilayer ceramic capacitors for use in electronic equipment, EIAJ RCR-2335 issued by Electronic Industries Association of Japan.



STANDARDIZATION

The following series were discontinued. Please use the replacements in the table.

◆ MULTILAYER CERAMIC CHIP CAPACITORS

Discontinued series	Characteristics	Replacements	Page
TCCS	Y5U, Termination (Tin Plating)	NTS	13
TCCR	Y5U, Termination (Silver)	NTS	13
THCS	Y5U, Termination (Tin Plating), Down sized	NTS	13
THCR	Y5U, Termination (Silver), Down sized	NTS	13
TMCS	Y5U, Termination (Tin Plating), High Reliability	NTF	13

◆ METAL CAP TYPE MULTILAYER CERAMIC CAPACITORS

Discontinued series	Characteristics	Replacements	Page
TCP	Y5U	NTJ	22
THP	Y5U, Down sized	NTJ	22
TMP	Y5U, Down sized, High Reliability	NTJ	22

◆ DIPPED RADIAL LEAD MULTILAYER CERAMIC CAPACITORS

Discontinued series	Characteristics	Replacements	Page
TCD	Y5U	NTD	28
THD	Y5U, Down sized	NTD	28

Lead oxides are included as a dielectric material in the discontinued series (Y5U characteristics) on the above lists. Under RoHS directive, such Lead (Pb) was already restricted from January 1, 2013. Under ELV directive, it is restricted from January 1, 2016. Please use the replacements which are RoHS compliant.

NTS Series / NTF Series

(General product)

Temperature cycle : 1000 cycles



◆FEATURES

1. Large capacitance by small size.
2. X7R and X7S temperature characteristics.
3. High permissible ripple current capability.
4. NTF: Temperature cycle : 1000 cycles.



◆APPLICATIONS

1. Smoothing circuit of DC-DC converters.
2. On-board power supplies.
3. Voltage regulators for computers.
3. Noise suppressor for various kinds of equipments.
4. High reliability equipments.

◆CONSTRUCTION

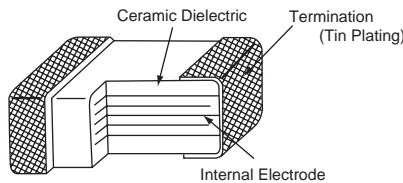

◆RATINGS

1. Category Temperature Range	-55 to +125°C
2. Rated Voltage Range	25, 35, 50, 100, 250, 500V _{dc}
3. Rated Capacitance Range	0.010 to 47μF
4. Rated Capacitance Tolerance	M (±20%), K (±10%)
5. Temperature Characteristics	X7R
6. Rated Ripple Current	See No.5 on the following table

◆SPECIFICATIONS

No.	Items	Specification	Test Condition		
1	Withstand Voltage	No abnormality.	Rated voltage	Withstand voltage	
			Less than 250V	250% of rated voltage	
			More than 250V Less than 500V	100V + 150% of rated voltage	
			More than 500V	130% of rated voltage	
			Shall be applied for 5 seconds.		
2	Insulation Resistance	100/C _R (MΩ) or 4000(MΩ) whichever is less.	Rated voltage shall be applied for 60±5 seconds at temperature 25±2°C.		
3	Rated Capacitance	Within specified tolerance.		C _R ≤10μF	C _R >10μF
			Temperature	25±2°C	
4	Dissipation Factor	X7R temperature characteristics of 5.0% or less X7S temperature characteristics of 7.5% or less	Frequency	1±0.1kHz	120±12Hz
			Voltage	1±0.2Vrms	0.5±0.2Vrms
			10kHz~1MHz (sine curve) Ripple voltage V _p shall be less than the rated voltage.		
5	Rated Ripple Current	See STANDARD RATINGS			

As customer requirement, Chemi-Con has submits the test results according to AEC-Q200 for Multilayer ceramic capacitors. Please contact us for more information.



NTS Series / NTF Series

◆SPECIFICATIONS

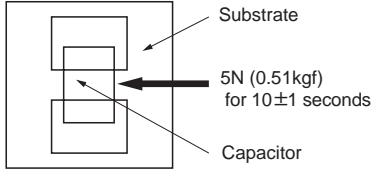
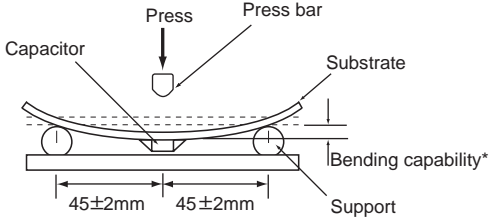
No.	Items	Specification	Test Condition															
6	Adhesion	No visible damage.																
7	Bend strength of the face plating	Appearance : No visible damage. $\Delta C/C : \pm 15\%$	<p>The substrate shall be bend at a rate of 1mm/s for 5 seconds.</p>  <p>*Bending capability NTS : 1mm NTF : 1mm or 2mm</p>															
8	Solderability	Min. 75% of surface of the termination shall be covered with new solder	<table border="1" data-bbox="927 954 1452 1048"> <tr> <td>Solder</td> <td>Pb Free</td> </tr> <tr> <td>Solder Temperature</td> <td>245±5°C</td> </tr> <tr> <td>Dipping Time</td> <td>2±0.5sec.</td> </tr> </table>	Solder	Pb Free	Solder Temperature	245±5°C	Dipping Time	2±0.5sec.									
Solder	Pb Free																	
Solder Temperature	245±5°C																	
Dipping Time	2±0.5sec.																	
9	Resistance to Soldering Heat	Appearance : No visible damage. $\Delta C/C : \pm 15\%$ D.F. : To meet the initial specification. I.R. : To meet the initial specification.	<p>Preheating Condition :</p> <table border="1" data-bbox="927 1095 1452 1182"> <thead> <tr> <th>Step</th> <th>Temperature</th> <th>Time</th> </tr> </thead> <tbody> <tr> <td>1</td> <td>100±10°C</td> <td>2min.</td> </tr> <tr> <td>2</td> <td>200±10°C</td> <td>2min.</td> </tr> </tbody> </table> <p>Solder Temperature : 260±5°C Dipping Time : 2±0.5 seconds</p>	Step	Temperature	Time	1	100±10°C	2min.	2	200±10°C	2min.						
Step	Temperature	Time																
1	100±10°C	2min.																
2	200±10°C	2min.																
10	Temperature Cycle	Appearance : No visible damage. $\Delta C/C : \pm 15\%$ D.F. : To meet the initial specification. I.R. : To meet the initial specification.	<table border="1" data-bbox="927 1283 1452 1433"> <thead> <tr> <th>Step</th> <th>Temperature (°C)</th> <th>(min.)</th> </tr> </thead> <tbody> <tr> <td>1</td> <td>Min. Category temperature ±3</td> <td>30±3</td> </tr> <tr> <td>2</td> <td>Room temperature</td> <td>3 max.</td> </tr> <tr> <td>3</td> <td>Max. Category temperature ±3</td> <td>30±3</td> </tr> <tr> <td>4</td> <td>Room temperature</td> <td>3 max.</td> </tr> </tbody> </table> <p>For above temperature cycle. NTS : For 5 cycles NTF : For 1000 cycles</p>	Step	Temperature (°C)	(min.)	1	Min. Category temperature ±3	30±3	2	Room temperature	3 max.	3	Max. Category temperature ±3	30±3	4	Room temperature	3 max.
Step	Temperature (°C)	(min.)																
1	Min. Category temperature ±3	30±3																
2	Room temperature	3 max.																
3	Max. Category temperature ±3	30±3																
4	Room temperature	3 max.																
11	Humidity Load Life	Appearance : No abnormality. $\Delta C/C : \pm 15\%$ I.R. : 25/C _R (M Ω) or 1000(M Ω) whichever is less. Dissipation Factor X7R temperature characteristics D.F: 10% or less X7S temperature characteristics D.F: 15% or less	<p>Temperature : 40±2°C Humidity : 90 to 95%RH Voltage : Rated voltage Time : 500±²⁴₀hours</p>															
12	Endurance	Appearance : No abnormality. $\Delta C/C : \pm 15\%$ I.R. : 50/C _R (M Ω) or 1000(M Ω) whichever is less. Dissipation Factor X7R temperature characteristics D.F: 10% or less X7S temperature characteristics D.F: 15% or less	<p>Temperature : 125±3°C Voltage : Rated voltage Time : 1000±⁴⁸₀hours</p>															

*C_R : Rated Capacitance(μF)

◆ STANDARD RATINGS

Rated voltage (Vdc)	Rated Capacitance (μF)	Electrostatic Capacitance Temperature Characteristics	Case Code	Dimensions(mm)				Maximum ripple current (Arms)	Part Number	Taping Quantity per reel (pcs. / reel)	
				inch / mm	L	W	T max.				a
25	1.0	X7R	1206 / 3216	3.2±0.2	1.6±0.2	1.8	0.5±0.3	0.3	KTS250B105□31N0T00	3,000	
	1.5	X7R	1206 / 3216	3.2±0.2	1.6±0.2	1.8	0.5±0.3	0.3	KTS250B155□31N0T00	3,000	
	2.2	X7R	1206 / 3216	3.2±0.2	1.6±0.2	1.8	0.5±0.3	0.3	KTS250B225□31N0T00	3,000	
	3.3	X7S	1206 / 3216	3.2±0.2	1.6±0.2	1.8	0.5±0.3	0.3	KTS250S335□31N0T00	2,000	
	3.3	X7R	1210 / 3225	3.2±0.4	2.5±0.3	2.6	0.6±0.3	0.5	KTS250B335□32N0T00	1,600	
	4.7	X7R	1210 / 3225	3.2±0.4	2.5±0.3	2.6	0.6±0.3	0.5	KTS250B475□32N0T00	1,600	
	6.8	X7R	1210 / 3225	3.2±0.4	2.5±0.3	2.6	0.6±0.3	0.5	KTS250B685□32N0T00	1,600	
	10	X7S	1210 / 3225	3.2±0.4	2.5±0.3	2.6	0.6±0.3	0.5	KTS250S106□32N0T00	1,600	
	10	X7R	1812 / 4532	4.5±0.4	3.2±0.4	2.8	0.6±0.3	1.0	KTS250B106□43N0T00	800	
	15	X7R	1812 / 4532	4.5±0.4	3.2±0.4	2.8	0.6±0.3	1.0	KTS250B156□43N0T00	800	
	22	X7S	1812 / 4532	4.5±0.4	3.2±0.4	2.8	0.6±0.3	1.0	KTS250S226□43N0T00	800	
	22	X7R	2220 / 5750	5.7±0.4	5.0±0.4	2.8	0.8±0.5	2.0	KTS250B226□55N0T00	800	
	33	X7R	2220 / 5750	5.7±0.4	5.0±0.4	3.0	0.8±0.5	2.0	KTS250B336□55N0T00	800	
47	X7R	3025 / 7563	7.5±0.5	6.3±0.5	4.0	1.0±0.5	3.0	KTS250B476□76N0T00	300		
35	1.0	X7R	1206 / 3216	3.2±0.2	1.6±0.2	1.8	0.5±0.3	0.3	KTS350B105□31N0T00	3,000	
	1.5	X7R	1206 / 3216	3.2±0.2	1.6±0.2	1.8	0.5±0.3	0.3	KTS350B155□31N0T00	3,000	
	2.2	X7R	1206 / 3216	3.2±0.2	1.6±0.2	1.8	0.5±0.3	0.3	KTS350B225□31N0T00	3,000	
	3.3	X7R	1210 / 3225	3.2±0.4	2.5±0.3	2.6	0.6±0.3	0.5	KTS350B335□32N0T00	1,600	
	4.7	X7R	1210 / 3225	3.2±0.4	2.5±0.3	2.6	0.6±0.3	0.5	KTS350B475□32N0T00	1,600	
	6.8	X7R	1812 / 4532	4.5±0.4	3.2±0.4	2.8	0.6±0.3	1.0	KTS350B685□43N0T00	800	
	10	X7R	1812 / 4532	4.5±0.4	3.2±0.4	2.8	0.6±0.3	1.0	KTS350B106□43N0T00	800	
	15	X7R	2220 / 5750	5.7±0.4	5.0±0.4	2.8	0.8±0.5	2.0	KTS350B156□55N0T00	800	
	22	X7R	2220 / 5750	5.7±0.4	5.0±0.4	2.8	0.8±0.5	2.0	KTS350B226□55N0T00	800	
	33	X7R	3025 / 7563	7.5±0.5	6.3±0.5	4.0	1.0±0.5	3.0	KTS350B336□76N0T00	300	
	47	X7R	3025 / 7563	7.5±0.5	6.3±0.5	4.0	1.0±0.5	3.0	KTS350B476□76N0T00	300	
	50	0.33	X7R	1206 / 3216	3.2±0.2	1.6±0.2	1.8	0.5±0.3	0.3	KTS500B334□31N0T00	3,000
		0.47	X7R	1206 / 3216	3.2±0.2	1.6±0.2	1.8	0.5±0.3	0.3	KTS500B474□31N0T00	3,000
0.68		X7R	1206 / 3216	3.2±0.2	1.6±0.2	1.8	0.5±0.3	0.3	KTS500B684□31N0T00	3,000	
1.0		X7R	1206 / 3216	3.2±0.2	1.6±0.2	1.8	0.5±0.3	0.3	KTS500B105□31N0T00	3,000	
1.5		X7R	1206 / 3216	3.2±0.2	1.6±0.2	1.8	0.5±0.3	0.3	KTS500B155□31N0T00	2,000	
2.2		X7R	1206 / 3216	3.2±0.2	1.6±0.2	1.8	0.5±0.3	0.3	KTS500B225□31N0T00	2,000	
1.5		X7R	1210 / 3225	3.2±0.4	2.5±0.3	2.6	0.6±0.3	0.5	KTS500B155□32N0T00	1,600	
2.2		X7R	1210 / 3225	3.2±0.4	2.5±0.3	2.6	0.6±0.3	0.5	KTS500B225□32N0T00	1,600	
3.3		X7R	1210 / 3225	3.2±0.4	2.5±0.3	2.6	0.6±0.3	0.5	KTS500B335□32N0T00	1,600	
4.7		X7R	1210 / 3225	3.2±0.4	2.5±0.3	2.6	0.6±0.3	0.5	KTS500B475□32N0T00	1,600	
4.7		X7R	1812 / 4532	4.5±0.4	3.2±0.4	2.8	0.6±0.3	1.0	KTS500B475□43N0T00	800	
6.8		X7R	1812 / 4532	4.5±0.4	3.2±0.4	2.8	0.6±0.3	1.0	KTS500B685□43N0T00	800	
10		X7R	1812 / 4532	4.5±0.4	3.2±0.4	2.8	0.6±0.3	1.0	KTS500B106□43N0T00	800	
10	X7R	2220 / 5750	5.7±0.4	5.0±0.4	2.8	0.8±0.5	2.0	KTS500B106□55N0T00	800		
15	X7R	2220 / 5750	5.7±0.4	5.0±0.4	2.8	0.8±0.5	2.0	KTS500B156□55N0T00	800		
22	X7R	3025 / 7563	7.5±0.5	6.3±0.5	4.0	1.0±0.5	3.0	KTS500B226□76N0T00	300		
100	0.1	X7R	1206 / 3216	3.2±0.2	1.6±0.2	1.8	0.5±0.3	0.3	KTS101B104□31N0T00	3,000	
	0.15	X7R	1206 / 3216	3.2±0.2	1.6±0.2	1.8	0.5±0.3	0.3	KTS101B154□31N0T00	3,000	
	0.22	X7R	1206 / 3216	3.2±0.2	1.6±0.2	1.8	0.5±0.3	0.3	KTS101B224□31N0T00	3,000	
	0.33	X7R	1206 / 3216	3.2±0.2	1.6±0.2	1.8	0.5±0.3	0.3	KTS101B334□31N0T00	3,000	
	0.47	X7R	1206 / 3216	3.2±0.2	1.6±0.2	1.8	0.5±0.3	0.3	KTS101B474□31N0T00	3,000	
	0.68	X7R	1206 / 3216	3.2±0.2	1.6±0.2	1.8	0.5±0.3	0.3	KTS101B684□31N0T00	3,000	
	1.0	X7R	1206 / 3216	3.2±0.2	1.6±0.2	1.8	0.5±0.3	0.3	KTS101B105□31N0T00	2,000	
	1.5	X7R	1206 / 3216	3.2±0.2	1.6±0.2	1.8	0.5±0.3	0.3	KTS101B155□31N0T00	2,000	
	2.2	X7R	1206 / 3216	3.2±0.2	1.6±0.2	1.8	0.5±0.3	0.3	KTS101B225□31N0T00	2,000	
	1.0	X7R	1210 / 3225	3.2±0.4	2.5±0.3	2.6	0.6±0.3	0.5	KTS101B105□32N0T00	1,600	
	1.5	X7R	1210 / 3225	3.2±0.4	2.5±0.3	2.6	0.6±0.3	0.5	KTS101B155□32N0T00	1,600	
	2.2	X7R	1210 / 3225	3.2±0.4	2.5±0.3	2.6	0.6±0.3	0.5	KTS101B225□32N0T00	1,600	
	3.3	X7R	1210 / 3225	3.2±0.4	2.5±0.3	2.6	0.6±0.3	0.5	KTS101B335□32N0T00	1,600	
	4.7	X7R	1210 / 3225	3.2±0.4	2.5±0.3	2.6	0.6±0.3	0.5	KTS101B475□32N0T00	1,600	
	1.5	X7R	1812 / 4532	4.5±0.4	3.2±0.4	2.8	0.6±0.3	1.0	KTS101B155□43N0T00	800	
	2.2	X7R	1812 / 4532	4.5±0.4	3.2±0.4	2.8	0.6±0.3	1.0	KTS101B225□43N0T00	800	
	3.3	X7R	1812 / 4532	4.5±0.4	3.2±0.5	2.8	0.6±0.3	1.0	KTS101B335□43J0T00	800	
	4.7	X7R	1812 / 4532	4.5±0.4	3.2±0.5	3.2	0.6±0.3	1.0	KTS101B475□43E0T00	800	
	6.8	X7R	1812 / 4532	4.5±0.4	3.2±0.4	2.8	0.6±0.3	1.0	KTS101B685□43N0T00	800	
	3.3	X7R	2220 / 5750	5.7±0.4	5.0±0.4	2.8	0.8±0.5	2.0	KTS101B335□55N0T00	800	
	4.7	X7R	2220 / 5750	5.7±0.4	5.0±0.4	2.8	0.8±0.5	2.0	KTS101B475□55N0T00	800	
6.8	X7R	2220 / 5750	5.7±0.4	5.0±0.4	3.2	0.8±0.5	2.0	KTS101B685□55F0T00	800		
10	X7R	2220 / 5750	5.7±0.4	5.0±0.4	2.8	0.8±0.5	2.0	KTS101B106□55N0T00	800		
6.8	X7R	3025 / 7563	7.5±0.5	6.3±0.5	3.5	1.0±0.5	3.0	KTS101B685□76N0T00	300		

NTS Series

◆STANDARD RATINGS

Rated voltage (Vdc)	Rated Capacitance (μF)	Electrostatic Capacitance Temperature Characteristics	Case Code	Dimensions(mm)				Maximum ripple current (Arms)	Part Number	Taping Quantity per reel (pcs./reel)
				inch / mm	L	W	T max.			
250	0.01	X7R	1206 / 3216	3.2±0.2	1.6±0.2	1.8	0.5±0.3	0.3	KTS251B103□31N0T00	3,000
	0.022	X7R	1206 / 3216	3.2±0.2	1.6±0.2	1.8	0.5±0.3	0.3	KTS251B223□31N0T00	3,000
	0.033	X7R	1206 / 3216	3.2±0.2	1.6±0.2	1.8	0.5±0.3	0.3	KTS251B333□31N0T00	3,000
	0.047	X7R	1206 / 3216	3.2±0.2	1.6±0.2	1.8	0.5±0.3	0.3	KTS251B473□31N0T00	3,000
	0.068	X7R	1206 / 3216	3.2±0.2	1.6±0.2	1.8	0.5±0.3	0.3	KTS251B683□31N0T00	3,000
	0.1	X7R	1206 / 3216	3.2±0.2	1.6±0.2	1.8	0.5±0.3	0.3	KTS251B104□31N0T00	3,000
	0.15	X7R	1210 / 3225	3.2±0.4	2.5±0.3	2.6	0.6±0.3	0.5	KTS251B154□32N0T00	1,600
	0.22	X7R	1210 / 3225	3.2±0.4	2.5±0.3	2.6	0.6±0.3	0.5	KTS251B224□32N0T00	1,600
	0.33	X7R	1210 / 3225	3.2±0.4	2.5±0.3	2.6	0.6±0.3	0.5	KTS251B334□32N0T00	1,600
	0.47	X7R	1812 / 4532	4.5±0.4	3.2±0.4	2.8	0.6±0.3	1.0	KTS251B474□43N0T00	800
	0.68	X7R	1812 / 4532	4.5±0.4	3.2±0.4	2.8	0.6±0.3	1.0	KTS251B684□43N0T00	800
	1.0	X7R	2220 / 5750	5.7±0.4	5.0±0.4	2.8	0.8±0.5	2.0	KTS251B105□55N0T00	800
500	0.47	X7R	2220 / 5750	5.7±0.4	5.0±0.4	3.0	0.8±0.5	1.5	KTS501B564□55N0T00	800
	0.56	X7R	2220 / 5750	5.7±0.4	5.0±0.4	3.0	0.8±0.5	1.5	KTS501B684□76N0T00	500
	0.68	X7R	3025 / 7563	7.5±0.5	6.3±0.5	3.5	1.0±0.5	3.0	KTS251B155□76N0T00	300
	1.0	X7R	3025 / 7563	7.5±0.5	6.3±0.5	5.0	1.0±0.5	3.0	KTS251B225□76N0T00	300
	1.2	X7R	3025 / 7563	7.5±0.5	6.3±0.5	3.5	1.0±0.5	2.0	KTS501B105□76N0T00	300
	1.2	X7R	3025 / 7563	7.5±0.5	6.3±0.5	3.5	1.0±0.5	2.0	KTS501B125□76N0T00	300

※ The square (□) in part numbers is replaced by a capacitance tolerance code: 'K' when ±10%, or 'M' when ±20%
 ※ Please consult with us when you consider the rating other than a standard table.

◆PART NUMBERING SYSTEM

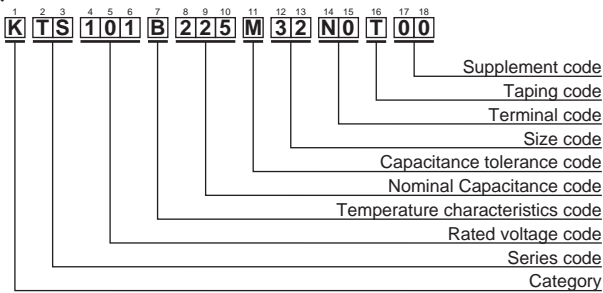

Size Code

Size Code	L × W (mm)
31	3.2 × 1.6
32	3.2 × 2.5
43	4.5 × 3.2
55	5.7 × 5.0
76	7.5 × 6.3

◆DIMENSIONS

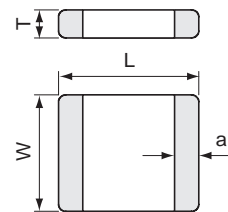

Please refer to "Part Numbering System" of the beginning of a catalog for the details.



MULTILAYER CERAMIC CHIP CAPACITORS

NTF Series

◆STANDARD RATINGS

Rated voltage (Vdc)	Rated Capacitance (μF)	Electrostatic Capacitance Temperature Characteristics	Case Code	Dimensions(mm)				Maximum ripple current (Arms)	Part Number	Taping Quantity per reel (pcs. / reel)
				inch / mm	L	W	T max.			
25	1.0	X7R	1206 / 3216	3.2±0.2	1.6±0.2	1.8	0.7±0.2	0.3	KTF250B105□31NLT00	3,000
	1.5	X7R	1206 / 3216	3.2±0.2	1.6±0.2	1.8	0.7±0.2	0.3	KTF250B155□31NLT00	3,000
	2.2	X7R	1206 / 3216	3.2±0.2	1.6±0.2	1.8	0.7±0.2	0.3	KTF250B225□31NLT00	3,000
	3.3	X7S	1206 / 3216	3.2±0.2	1.6±0.2	1.8	0.7±0.2	0.3	KTF250S335□31NLT00	2,000
	3.3	X7R	1210 / 3225	3.2±0.4	2.5±0.3	2.6	0.7±0.2	0.5	KTF250B335□32NHT00	1,600
	4.7	X7R	1210 / 3225	3.2±0.4	2.5±0.3	2.6	0.7±0.2	0.5	KTF250B475□32NHT00	1,600
	6.8	X7R	1210 / 3225	3.2±0.4	2.5±0.3	2.6	0.7±0.2	0.5	KTF250B685□32NHT00	1,600
	10	X7S	1210 / 3225	3.2±0.4	2.5±0.3	2.6	0.7±0.2	0.5	KTF250S106□32NHT00	1,600
	10	X7R	1812 / 4532	4.5±0.4	3.2±0.4	2.8	0.7±0.2	1.0	KTF250B106□43NHT00	800
	15	X7R	1812 / 4532	4.5±0.4	3.2±0.4	2.8	0.7±0.2	1.0	KTF250B156□43NHT00	800
	22	X7S	1812 / 4532	4.5±0.4	3.2±0.4	2.8	0.7±0.2	1.0	KTF250S226□43NHT00	800
	22	X7R	2220 / 5750	5.7±0.4	5.0±0.4	2.8	1.0±0.4	2.0	KTF250B226□55NHT00	800
33	X7R	2220 / 5750	5.7±0.4	5.0±0.4	3.0	1.0±0.4	2.0	KTF250B336□55NHT00	800	
35	1.0	X7R	1206 / 3216	3.2±0.2	1.6±0.2	1.8	0.7±0.2	0.3	KTF350B105□31NLT00	3,000
	1.5	X7R	1206 / 3216	3.2±0.2	1.6±0.2	1.8	0.7±0.2	0.3	KTF350B155□31NLT00	3,000
	2.2	X7R	1206 / 3216	3.2±0.2	1.6±0.2	1.8	0.7±0.2	0.3	KTF350B225□31NLT00	3,000
	3.3	X7R	1210 / 3225	3.2±0.4	2.5±0.3	2.6	0.7±0.2	0.5	KTF350B335□32NHT00	1,600
	4.7	X7R	1210 / 3225	3.2±0.4	2.5±0.3	2.6	0.7±0.2	0.5	KTF350B475□32NHT00	1,600
	6.8	X7R	1812 / 4532	4.5±0.4	3.2±0.4	2.8	0.7±0.2	1.0	KTF350B685□43NHT00	800
	10	X7R	1812 / 4532	4.5±0.4	3.2±0.4	2.8	0.7±0.2	1.0	KTF350B106□43NHT00	800
	15	X7R	2220 / 5750	5.7±0.4	5.0±0.4	2.8	1.0±0.4	2.0	KTF350B156□55NHT00	800
22	X7R	2220 / 5750	5.7±0.4	5.0±0.4	2.8	1.0±0.4	2.0	KTF350B226□55NHT00	800	
50	0.33	X7R	1206 / 3216	3.2±0.2	1.6±0.2	1.8	0.7±0.2	0.3	KTF500B334□31NLT00	3,000
	0.47	X7R	1206 / 3216	3.2±0.2	1.6±0.2	1.8	0.7±0.2	0.3	KTF500B474□31NLT00	3,000
	0.68	X7R	1206 / 3216	3.2±0.2	1.6±0.2	1.8	0.7±0.2	0.3	KTF500B684□31NLT00	3,000
	1.0	X7R	1206 / 3216	3.2±0.2	1.6±0.2	1.8	0.7±0.2	0.3	KTF500B105□31NLT00	3,000
	1.5	X7R	1206 / 3216	3.2±0.2	1.6±0.2	1.8	0.7±0.2	0.3	KTF500B155□31NLT00	2,000
	2.2	X7R	1206 / 3216	3.2±0.2	1.6±0.2	1.8	0.7±0.2	0.3	KTF500B225□31NLT00	2,000
	1.5	X7R	1210 / 3225	3.2±0.4	2.5±0.3	2.6	0.7±0.2	0.5	KTF500B155□32NHT00	1,600
	2.2	X7R	1210 / 3225	3.2±0.4	2.5±0.3	2.6	0.7±0.2	0.5	KTF500B225□32NHT00	1,600
	3.3	X7R	1210 / 3225	3.2±0.4	2.5±0.3	2.6	0.7±0.2	0.5	KTF500B335□32NHT00	1,600
	4.7	X7R	1210 / 3225	3.2±0.4	2.5±0.3	2.6	0.7±0.2	0.5	KTF500B475□32NHT00	1,600
	4.7	X7R	1812 / 4532	4.5±0.4	3.2±0.4	2.8	0.7±0.2	1.0	KTF500B475□43NHT00	800
	6.8	X7R	1812 / 4532	4.5±0.4	3.2±0.4	2.8	0.7±0.2	1.0	KTF500B685□43NHT00	800
	10	X7R	1812 / 4532	4.5±0.4	3.2±0.4	2.8	0.7±0.2	1.0	KTF500B106□43NHT00	800
	10	X7R	2220 / 5750	5.7±0.4	5.0±0.4	2.8	1.0±0.4	2.0	KTF500B106□55NHT00	800
	15	X7R	2220 / 5750	5.7±0.4	5.0±0.4	2.8	1.0±0.4	2.0	KTF500B156□55NHT00	800
100	0.1	X7R	1206 / 3216	3.2±0.2	1.6±0.2	1.8	0.7±0.2	0.3	KTF101B104□31NLT00	3,000
	0.15	X7R	1206 / 3216	3.2±0.2	1.6±0.2	1.8	0.7±0.2	0.3	KTF101B154□31NLT00	3,000
	0.22	X7R	1206 / 3216	3.2±0.2	1.6±0.2	1.8	0.7±0.2	0.3	KTF101B224□31NLT00	3,000
	0.33	X7R	1206 / 3216	3.2±0.2	1.6±0.2	1.8	0.7±0.2	0.3	KTF101B334□31NLT00	3,000
	0.47	X7R	1206 / 3216	3.2±0.2	1.6±0.2	1.8	0.7±0.2	0.3	KTF101B474□31NLT00	3,000
	0.68	X7R	1206 / 3216	3.2±0.2	1.6±0.2	1.8	0.7±0.2	0.3	KTF101B684□31NLT00	3,000
	1.0	X7R	1206 / 3216	3.2±0.2	1.6±0.2	1.8	0.7±0.2	0.3	KTF101B105□31NLT00	2,000
	1.5	X7R	1206 / 3216	3.2±0.2	1.6±0.2	1.8	0.7±0.2	0.3	KTF101B155□31NLT00	2,000
	2.2	X7R	1206 / 3216	3.2±0.2	1.6±0.2	1.8	0.7±0.2	0.3	KTF101B225□31NLT00	2,000
	1.0	X7R	1210 / 3225	3.2±0.4	2.5±0.3	2.6	0.7±0.2	0.5	KTF101B105□32NHT00	1,600
	1.5	X7R	1210 / 3225	3.2±0.4	2.5±0.3	2.6	0.7±0.2	0.5	KTF101B155□32NHT00	1,600
	2.2	X7R	1210 / 3225	3.2±0.4	2.5±0.3	2.6	0.7±0.2	0.5	KTF101B225□32NHT00	1,600
	3.3	X7R	1210 / 3225	3.2±0.4	2.5±0.3	2.6	0.7±0.2	0.5	KTF101B335□32NHT00	1,600
	4.7	X7R	1210 / 3225	3.2±0.4	2.5±0.3	2.6	0.7±0.2	0.5	KTF101B475□32NHT00	1,600
	1.5	X7R	1812 / 4532	4.5±0.4	3.2±0.4	2.8	0.7±0.2	1.0	KTF101B155□43NHT00	800
	2.2	X7R	1812 / 4532	4.5±0.4	3.2±0.4	2.8	0.7±0.2	1.0	KTF101B225□43NHT00	800
	3.3	X7R	1812 / 4532	4.5±0.4	3.2±0.5	2.8	0.7±0.2	1.0	KTF101B335□43JHT00	800
	4.7	X7R	1812 / 4532	4.5±0.4	3.2±0.5	3.2	0.7±0.2	1.0	KTF101B475□43EHT00	800
	6.8	X7R	1812 / 4532	4.5±0.4	3.2±0.4	2.8	0.7±0.2	1.0	KTF101B685□43NHT00	800
	4.7	X7R	2220 / 5750	5.7±0.4	5.0±0.4	2.8	1.0±0.4	2.0	KTF101B475□55NHT00	800
6.8	X7R	2220 / 5750	5.7±0.4	5.0±0.4	3.2	1.0±0.4	2.0	KTF101B685□55FHT00	800	
10	X7R	2220 / 5750	5.7±0.4	5.0±0.4	2.8	1.0±0.4	2.0	KTF101B106□55NHT00	800	

NTF Series

◆STANDARD RATINGS

Rated voltage (Vdc)	Rated Capacitance (μF)	Electrostatic Capacitance Temperature Characteristics	Case Code	Dimensions(mm)				Maximum ripple current (Arms)	Part Number	Taping Quantity per reel (pcs. / reel)
			inch / mm	L	W	T max.	a			
250	0.033	X7R	1206 / 3216	3.2±0.2	1.6±0.2	1.8	0.7±0.2	0.3	KTF251B333□31NLT00	3,000
	0.047	X7R	1206 / 3216	3.2±0.2	1.6±0.2	1.8	0.7±0.2	0.3	KTF251B473□31NLT00	3,000
	0.068	X7R	1206 / 3216	3.2±0.2	1.6±0.2	1.8	0.7±0.2	0.3	KTF251B683□31NLT00	3,000
	0.1	X7R	1206 / 3216	3.2±0.2	1.6±0.2	1.8	0.7±0.2	0.3	KTF251B104□31NLT00	3,000
	0.15	X7R	1210 / 3225	3.2±0.4	2.5±0.3	2.6	0.7±0.2	0.5	KTF251B154□32NLT00	1,600
	0.22	X7R	1210 / 3225	3.2±0.4	2.5±0.3	2.6	0.7±0.2	0.5	KTF251B224□32NLT00	1,600
	0.33	X7R	1210 / 3225	3.2±0.4	2.5±0.3	2.6	0.7±0.2	0.5	KTF251B334□32NLT00	1,600
	0.47	X7R	1812 / 4532	4.5±0.4	3.2±0.4	2.8	0.7±0.2	1.0	KTF251B474□43NLT00	800
	0.68	X7R	1812 / 4532	4.5±0.4	3.2±0.4	2.8	0.7±0.2	1.0	KTF251B684□43NLT00	800
500	1.0	X7R	2220 / 5750	5.7±0.4	5.0±0.4	2.8	1.0±0.4	2.0	KTF251B105□55NLT00	800
	1.5	X7R	2220 / 5750	5.7±0.4	5.0±0.4	2.8	1.0±0.4	2.0	KTF251B155□55NLT00	800
	0.47	X7R	2220 / 5750	5.7±0.4	5.0±0.4	2.7	1.0±0.4	1.5	KTF501B474□55NLT00	800
	0.56	X7R	2220 / 5750	5.7±0.4	5.0±0.4	3.0	1.0±0.4	1.5	KTF501B564□55NLT00	800

※ The square (□) in part numbers is replaced by a capacitance tolerance code: 'K' when ±10%, or 'M' when ±20%
 ※ Please consult with us when you consider the rating other than a standard table.

◆PART NUMBERING SYSTEM

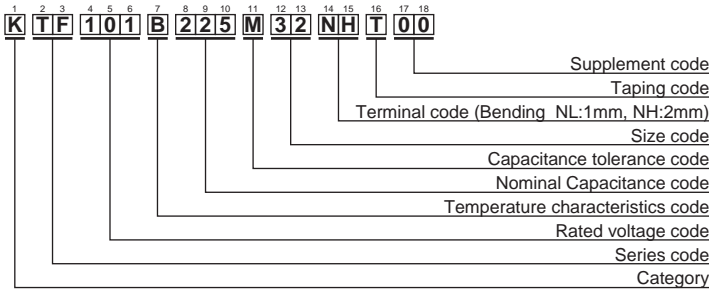

Size Code

Size Code	L x W (mm)
31	3.2 x 1.6
32	3.2 x 2.5
43	4.5 x 3.2
55	5.7 x 5.0
76	7.5 x 6.3

◆DIMENSIONS

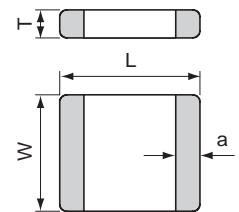

Please refer to "Part Numbering System" of the beginning of a catalog for the details.

KVF Series



Temperature cycle : 1000 cycles

◆FEATURES

1. Temperature range : -55 to +150°C
2. Temperature characteristics : X8L
3. Excellent noise absorption.
4. Automotive grade (AEC-Q200)



◆APPLICATIONS

1. Noise filter for automotive equipment (ECU etc.)
2. Equipment used in a high temperature environment

◆CONSTRUCTION

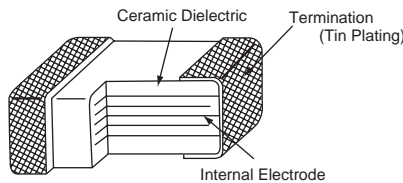

◆RATINGS

1. Category Temperature Range	-55~+150°C
2. Rated Voltage Range	25, 50, 100 Vdc
3. Rated Capacitance Range	0.033~15μF
4. Rated Capacitance Tolerance	M(±20%), K(±10%)
5. Temperature Characteristics	X8L
6. Rated Ripple Current	See No.5 on the following table

◆SPECIFICATIONS

No.	Items	Specification	Test Condition												
1	Withstand Voltage	No abnormality.	250% of rated voltage shall be applied for 5 seconds.												
2	Insulation Resistance	100/C _R (MΩ) or 4000(MΩ) whichever is less.	Rated voltage shall be applied for 60±5 seconds at temperature 25±2°C.												
3	Rated Capacitance	Within specified tolerance.	<table border="1"> <tr> <td></td> <td>C_R≤10μF</td> <td>C_R>10μF</td> </tr> <tr> <td>Temperature</td> <td colspan="2">25±2°C</td> </tr> <tr> <td>Frequency</td> <td>1±0.1kHz</td> <td>120±12Hz</td> </tr> <tr> <td>Voltage</td> <td>1±0.2Vrms</td> <td>0.5±0.2Vrms</td> </tr> </table>		C _R ≤10μF	C _R >10μF	Temperature	25±2°C		Frequency	1±0.1kHz	120±12Hz	Voltage	1±0.2Vrms	0.5±0.2Vrms
	C _R ≤10μF	C _R >10μF													
Temperature	25±2°C														
Frequency	1±0.1kHz	120±12Hz													
Voltage	1±0.2Vrms	0.5±0.2Vrms													
4	Dissipation Factor	5.0% maximum.													
5	Rated Ripple Current	<table border="1"> <tr> <td>Size code</td> <td>31</td> <td>32</td> <td>43</td> <td>55</td> </tr> <tr> <td>Arms</td> <td>0.3</td> <td>0.5</td> <td>1.0</td> <td>2.0</td> </tr> </table>	Size code	31	32	43	55	Arms	0.3	0.5	1.0	2.0	10kHz~1MHz (sine curve) Ripple voltage V _p shall be less than the rated voltage. The surface temperature MLCC must not exceed the maximum category temperature when the ripple current is applied.		
Size code	31	32	43	55											
Arms	0.3	0.5	1.0	2.0											

As customer requirement, Chemi-Con has submits the test results according to AEC-Q200 for Multilayer ceramic capacitors. Please contact us for more information.

◆SPECIFICATIONS

No.	Items	Specification	Test Condition															
6	High Temperature Exposure (Storage)	Appearance : No abnormality. ΔC/C : ±20% D.F. : 10% maximum I.R. : 50/C _R (MΩ) or 1000(MΩ) whichever is less.	Temperature : Max. category temperature ±3°C Time : 1000 ± ⁴⁸ ₀ hours															
7	Temperature Cycle	Appearance : No visible damage. ΔC/C : ±15% D.F. : To meet the initial specification. I.R. : To meet the initial specification.	<table border="1"> <thead> <tr> <th>Step</th> <th>Temperature (°C)</th> <th>(min.)</th> </tr> </thead> <tbody> <tr> <td>1</td> <td>Min. Category temperature ±3</td> <td>30 ±3</td> </tr> <tr> <td>2</td> <td>Room temperature</td> <td>3 max.</td> </tr> <tr> <td>3</td> <td>Max. Category temperature ±3</td> <td>30 ±3</td> </tr> <tr> <td>4</td> <td>Room temperature</td> <td>3 max.</td> </tr> </tbody> </table> <p>(Epoxy resin PCB t=1.6mm) For 1000 cycles</p>	Step	Temperature (°C)	(min.)	1	Min. Category temperature ±3	30 ±3	2	Room temperature	3 max.	3	Max. Category temperature ±3	30 ±3	4	Room temperature	3 max.
Step	Temperature (°C)	(min.)																
1	Min. Category temperature ±3	30 ±3																
2	Room temperature	3 max.																
3	Max. Category temperature ±3	30 ±3																
4	Room temperature	3 max.																
8	Biased Humidity	Appearance : No abnormality. ΔC/C : ±20% D.F. : 10% maximum I.R. : 25/C _R (MΩ) or 1000(MΩ) whichever is less.	Temperature : 85°C ±3°C Humidity : 80 ~ 85%RH Voltage : Rated voltage Time : 1000 ± ⁴⁸ ₀ hours															
9	Operational Life	Appearance : No abnormality. ΔC/C : ±20% D.F. : 10% maximum I.R. : 50/C _R (MΩ) or 1000(MΩ) whichever is less.	Temperature : Max. category temperature ±3°C Voltage : Rated voltage Time : 1000 ± ⁴⁸ ₀ hours															
10	Mechanical Shock	Appearance : No abnormality. ΔC/C : To meet the initial specification. D.F. : To meet the initial specification.	MIL-STD-202 Method213 Condition F Peak value : 1,500 G Normal duration : 0.5 ms Velocity change : 15.4 ft/sec (4.7m/s) Direction and time : 3 times each in X, Y, Z axis. Total 18 times															
11	Resistance to Soldering Heat	Appearance : No visible damage. ΔC/C : ±15% D.F. : To meet the initial specification. I.R. : To meet the initial specification.	Preheating temperature : 150 ±10°C Preheating time : 1 to 2 minute Solder temp. : 260 ±5°C Dipping Time : 10 ±1s															
12	ESD	Appearance : No abnormality. ΔC/C : To meet the initial specification. D.F. : To meet the initial specification. I.R. : To meet the initial specification.	AEC-Q200-002 Connection : Between terminals Direct Contact : 8kV (150pF 2000Ω) Times : ±1time															
13	Solderability	Min. 75% of surface of the termination shall be covered with new solder.	<table border="1"> <thead> <tr> <th>Solder</th> <th>Pb Free</th> </tr> </thead> <tbody> <tr> <td>Solder Temperature</td> <td>245 ±5°C</td> </tr> <tr> <td>Dipping Time</td> <td>2 ±0.5s</td> </tr> </tbody> </table>	Solder	Pb Free	Solder Temperature	245 ±5°C	Dipping Time	2 ±0.5s									
Solder	Pb Free																	
Solder Temperature	245 ±5°C																	
Dipping Time	2 ±0.5s																	
14	Board Flex	Appearance : No visible damage. ΔC/C : ±15%	<p>The substrate shall be bend at rate of 1mm/s for 5 seconds.</p> <p>* Bending capability : 1mm or 2mm</p>															
15	Terminal Strength (SMD)	No visible damage.	<p>17.7N 60 ±1 seconds</p>															

*C_R : Rated Capacitance(μF)

◆STANDARD RATINGS

Rated voltage (Vdc)	Rated Capacitance (μF)	Electrostatic Capacitance Temperature Characteristics	Case Code		Dimensions(mm)				Maximum ripple current (Arms)	Part Number	Taping Quantity per reel (pcs./reel)
			inch / mm	L	W	T max.	a				
25	0.33	X8L	1206 / 3216	3.2±0.3	1.6±0.2	1.8	0.7±0.2	0.3	KVF250L334□31NLT00	3,000	
	0.47	X8L	1206 / 3216	3.2±0.3	1.6±0.2	1.8	0.7±0.2	0.3	KVF250L474□31NLT00	3,000	
	0.68	X8L	1206 / 3216	3.2±0.3	1.6±0.2	1.8	0.7±0.2	0.3	KVF250L684□31NLT00	3,000	
	1.0	X8L	1206 / 3216	3.2±0.3	1.6±0.2	1.8	0.7±0.2	0.3	KVF250L105□31NLT00	3,000	
	1.5	X8L	1210 / 3225	3.2±0.4	2.5±0.3	2.6	0.7±0.2	0.5	KVF250L155□32NHT00	1,600	
	2.2	X8L	1210 / 3225	3.2±0.4	2.5±0.3	2.6	0.7±0.2	0.5	KVF250L225□32NHT00	1,600	
	3.3	X8L	1210 / 3225	3.2±0.4	2.5±0.3	2.6	0.7±0.2	0.5	KVF250L335□32NHT00	1,600	
	4.7	X8L	1812 / 4535	4.5±0.4	3.2±0.4	2.8	0.7±0.2	1.0	KVF250L475□43NHT00	800	
	6.8	X8L	1812 / 4535	4.5±0.4	3.2±0.4	2.8	0.7±0.2	1.0	KVF250L685□43NHT00	800	
50	10	X8L	2220 / 5750	5.7±0.4	5.0±0.4	2.8	1.0±0.4	2.0	KVF250L106□55NHT00	800	
	15	X8L	2220 / 5750	5.7±0.4	5.0±0.4	2.8	1.0±0.4	2.0	KVF250L156□55NHT00	800	
	0.10	X8L	1206 / 3216	3.2±0.2	1.6±0.2	1.8	0.7±0.2	0.3	KVF500L104□31NLT00	3,000	
	0.15	X8L	1206 / 3216	3.2±0.2	1.6±0.2	1.8	0.7±0.2	0.3	KVF500L154□31NLT00	3,000	
	0.22	X8L	1206 / 3216	3.2±0.2	1.6±0.2	1.8	0.7±0.2	0.3	KVF500L224□31NLT00	3,000	
	0.33	X8L	1206 / 3216	3.2±0.2	1.6±0.2	1.8	0.7±0.2	0.3	KVF500L334□31NLT00	3,000	
	0.47	X8L	1206 / 3216	3.2±0.2	1.6±0.2	1.8	0.7±0.2	0.3	KVF500L474□31NLT00	3,000	
	0.68	X8L	1210 / 3225	3.2±0.4	2.5±0.3	2.6	0.7±0.2	0.5	KVF500L684□32NLT00	1,600	
	1.0	X8L	1210 / 3225	3.2±0.4	2.5±0.3	2.6	0.7±0.2	0.5	KVF500L105□32NHT00	1,600	
100	1.5	X8L	1812 / 4532	4.5±0.4	3.2±0.4	2.8	0.7±0.2	1.0	KVF500L155□43NHT00	800	
	2.2	X8L	1812 / 4532	4.5±0.4	3.2±0.4	2.8	0.7±0.2	1.0	KVF500L225□43NHT00	800	
	3.3	X8L	2220 / 5750	5.7±0.4	5.0±0.4	2.8	1.0±0.4	2.0	KVF500L335□55NLT00	800	
	4.7	X8L	2220 / 5750	5.7±0.4	5.0±0.4	2.8	1.0±0.4	2.0	KVF500L475□55NHT00	800	
	6.8	X8L	2220 / 5750	5.7±0.4	5.0±0.4	2.8	1.0±0.4	2.0	KVF500L685□55NHT00	800	
	0.033	X8L	1206 / 3216	3.2±0.2	1.6±0.2	1.8	0.7±0.2	0.3	KVF101L333□31NLT00	3,000	
	0.047	X8L	1206 / 3216	3.2±0.2	1.6±0.2	1.8	0.7±0.2	0.3	KVF101L473□31NLT00	3,000	
	0.068	X8L	1206 / 3216	3.2±0.2	1.6±0.2	1.8	0.7±0.2	0.3	KVF101L683□31NLT00	3,000	
	0.1	X8L	1206 / 3216	3.2±0.2	1.6±0.2	1.8	0.7±0.2	0.3	KVF101L104□31NLT00	3,000	
100	0.15	X8L	1210 / 3225	3.2±0.4	2.5±0.3	2.6	0.7±0.2	0.5	KVF101L154□32NLT00	1,600	
	0.22	X8L	1210 / 3225	3.2±0.4	2.5±0.3	2.6	0.7±0.2	0.5	KVF101L224□32NLT00	1,600	
	0.3	X8L	1210 / 3225	3.2±0.4	2.5±0.3	2.6	0.7±0.2	0.5	KVF101L334□32NLT00	1,600	
	0.5	X8L	1812 / 4532	4.5±0.4	3.2±0.4	2.8	0.7±0.2	1.0	KVF101L474□43NLT00	800	
	0.68	X8L	1812 / 4532	4.5±0.4	3.2±0.4	2.8	0.7±0.2	1.0	KVF101L684□43NLT00	800	
	1.0	X8L	2220 / 5750	5.7±0.4	5.0±0.4	2.8	1.0±0.4	2.0	KVF101L105□55NLT00	800	
	1.5	X8L	2220 / 5750	5.7±0.4	5.0±0.4	2.8	1.0±0.4	2.0	KVF101L155□55NLT00	800	

※ The square (□) in part numbers is replaced by a capacitance tolerance code: 'K' when ±10%, or 'M' when ±20%
 ※ Please consult with us when you consider the rating other than a standard table.

◆PART NUMBERING SYSTEM

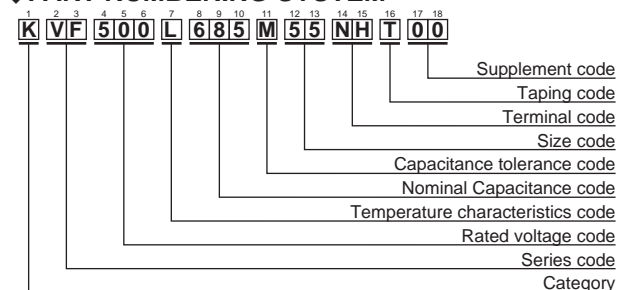

◆DIMENSIONS

Size Code

Size Code	L × W (mm)
31	3.2 × 1.6
32	3.2 × 2.5
43	4.5 × 3.2
55	5.7 × 5.0
76	7.5 × 6.3

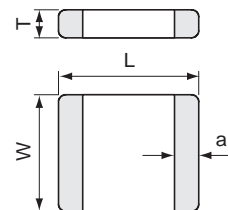

Please refer to "Part Numbering System" of the beginning of a catalog for the details.

◆FEATURES

1. Small size and large capacitance, high ripple current.
2. Temperature cycle: 1000 cycles.
3. X7R temperature characteristics.
4. Excellent noise absorption.
5. For reflow soldering use.
6. Suitable for aluminum substrate.

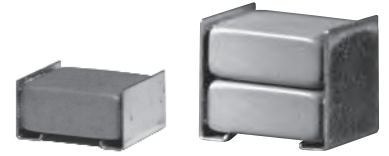

◆APPLICATIONS

1. Smoothing circuit of switching mode AC-DC or DC-DC converter.
2. On-board power supply.
3. Noise suppressor for various kinds of equipments.

◆CUSTOM MADE PRODUCTS

We can offer custom made one element metal cap type capacitors for request of customers. Please contact us if you have questions for details.

◆CONSTRUCTION

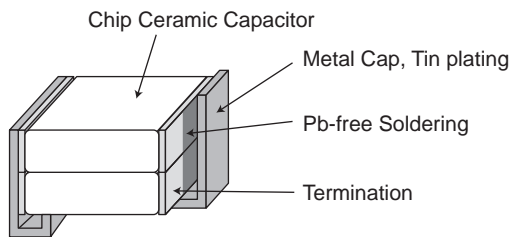

◆RATINGS

1. Category Temperature Range	-55~+125°C
2. Rated Voltage Range	25, 35, 50, 100, 250V _{dc}
3. Rated Capacitance Range	1.0 to 100μF
4. Rated Capacitance Tolerance	M(±20%)
5. Temperature Characteristics	X7R
6. Rated Ripple Current	See No.5 on the following table

◆SPECIFICATIONS

No.	Items	Specification	Test Condition		
1	Withstand Voltage	No abnormality.	250% of rated voltage shall be applied for 5 seconds. (Only 250V _{dc} products : 475V)		
2	Insulation Resistance	100/C _R (MΩ) or 4000(MΩ) whichever is less.	Rated voltage shall be applied for 60±5 seconds at temperature 25±2°C.		
3	Rated Capacitance	Within specified tolerance.		CR≤10μF	
				CR>10μF	
4	Dissipation Factor	5.0% maximum	Temperature	25±2°C	
			Frequency	1±0.1kHz	120±12Hz
			Voltage	1±0.2V _{rms}	0.5±0.2V _{rms}
5	Rated Ripple Current	See STANDARD RATINGS	10kHz~1MHz (sine curve) Ripple voltage V _p shall be less than the rated voltage.		

As customer requirement, Chemi-Con has submits the test results according to AEC-Q200 for Multilayer ceramic capacitors. Please contact us for more information.

◆SPECIFICATIONS

No.	Items	Specification	Test Condition															
6	Temperature Cycle	Appearance : No visible damage. $\Delta C/C : \pm 15\%$ D.F. : To meet the initial specification. I.R. : To meet the initial specification.	<table border="1"> <thead> <tr> <th>Step</th> <th>Temperature (°C)</th> <th>(min.)</th> </tr> </thead> <tbody> <tr> <td>1</td> <td>Min. Category temperature ± 3</td> <td>30\pm3</td> </tr> <tr> <td>2</td> <td>Room temperature</td> <td>3 max.</td> </tr> <tr> <td>3</td> <td>Max. Category temperature ± 3</td> <td>30\pm3</td> </tr> <tr> <td>4</td> <td>Room temperature</td> <td>3 max.</td> </tr> </tbody> </table> <Cycle> 1000 cycles	Step	Temperature (°C)	(min.)	1	Min. Category temperature ± 3	30 \pm 3	2	Room temperature	3 max.	3	Max. Category temperature ± 3	30 \pm 3	4	Room temperature	3 max.
Step	Temperature (°C)	(min.)																
1	Min. Category temperature ± 3	30 \pm 3																
2	Room temperature	3 max.																
3	Max. Category temperature ± 3	30 \pm 3																
4	Room temperature	3 max.																
7	Humidity Load Life	Appearance : No abnormality. $\Delta C/C : \pm 20\%$ D.F. : 10% max. I.R. : 25/C _R (M Ω) or 1000(M Ω) whichever is less.	Temperature : 40 \pm 2°C Humidity : 90 to 95%RH Voltage : Rated voltage Time : 500 \pm ²⁴ ₀ hours															
8	Endurance	Appearance : No abnormality. $\Delta C/C : \pm 20\%$ D.F. : 10% max. I.R. : 50/C _R (M Ω) or 1000(M Ω) whichever is less.	Temperature : 125 \pm 3°C Voltage : Rated voltage Time : 1000 \pm ⁴⁸ ₀ hours															

*C_R : Rated Capacitance(μ F)

◆Note of mountig for NTJ series.

1. The gap of capacitor and a substrate shall be the mounting face.
2. To prevent degradation of temperature cycling capability, if need to be careful about amount of solder that would not go into the inner side of terminations.

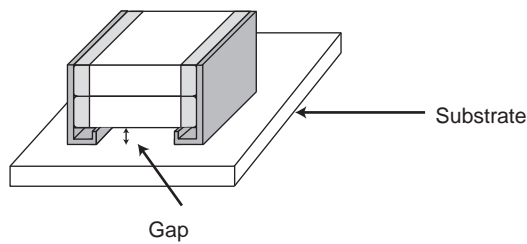

◆STANDARD RATINGS

Rated voltage (Vdc)	Rated Capacitance (μF)	Electrostatic Capacitance Temperature Characteristics	Case Code	Dimensions(mm)				Element	Maximum ripple current (Arms)	Part Number	Taping Quantity per reel (pcs. / reel)
				inch / mm	L	W	T max.				
25	33	X7R	2220 / 5750	6.0±0.4	5.3±0.4	3.8	1.3±0.3	1	2.0	KTJ250B336M55AFT00	400
	33	X7R	2220 / 5750	6.0±0.4	5.3±0.4	5.5	1.3±0.3	2	3.0	KTJ250B336M55BFT00	2,000
	47	X7R	2220 / 5750	6.0±0.4	5.3±0.4	5.5	1.3±0.3	2	3.0	KTJ250B476M55BFT00	2,000
	68	X7R	2220 / 5750	6.0±0.4	5.3±0.4	7.0	1.3±0.3	2	3.0	KTJ250B686M55BFT00	1,500
	47	X7R	3025 / 7563	7.8±0.5	6.6±0.5	5.5	1.5±0.3	1	3.0	KTJ250B476M76AFT00	1,200
	68	X7R	3025 / 7563	7.8±0.5	6.6±0.5	8.5	1.5±0.3	2	4.0	KTJ250B686M76BFT00	500
	100	X7R	3025 / 7563	7.8±0.5	6.6±0.5	9.5	1.5±0.3	2	4.0	KTJ250B107M76BFT00	400
35	33	X7R	2220 / 5750	6.0±0.4	5.3±0.4	5.5	1.3±0.3	2	3.0	KTJ350B336M55BFT00	2,000
	47	X7R	2220 / 5750	6.0±0.4	5.3±0.4	5.5	1.3±0.3	2	3.0	KTJ350B476M55BFT00	2,000
	47	X7R	3025 / 7563	7.8±0.5	6.6±0.5	5.5	1.5±0.3	1	3.0	KTJ350B476M76AFT00	1,200
	68	X7R	3025 / 7563	7.8±0.5	6.6±0.5	8.5	1.5±0.3	2	4.0	KTJ350B686M76BFT00	500
	100	X7R	3025 / 7563	7.8±0.5	6.6±0.5	8.5	1.5±0.3	2	4.0	KTJ350B107M76BFT00	500
50	15	X7R	2220 / 5750	6.0±0.4	5.3±0.4	3.8	1.3±0.3	1	2.0	KTJ500B156M55AFT00	400
	15	X7R	2220 / 5750	6.0±0.4	5.3±0.4	5.5	1.3±0.3	2	3.0	KTJ500B156M55BFT00	2,000
	22	X7R	2220 / 5750	6.0±0.4	5.3±0.4	5.5	1.3±0.3	2	3.0	KTJ500B226M55BFT00	2,000
	33	X7R	2220 / 5750	6.0±0.4	5.3±0.4	6.5	1.3±0.3	2	3.0	KTJ500B336M55BFT00	1,500
	22	X7R	3025 / 7563	7.8±0.5	6.6±0.5	5.5	1.5±0.3	1	3.0	KTJ500B226M76AFT00	1,200
	33	X7R	3025 / 7563	7.8±0.5	6.6±0.5	8.5	1.5±0.3	2	4.0	KTJ500B336M76BFT00	500
	47	X7R	3025 / 7563	7.8±0.5	6.6±0.5	8.5	1.5±0.3	2	4.0	KTJ500B476M76BFT00	500
100	4.7	X7R	2220 / 5750	6.0±0.4	5.3±0.4	3.8	1.3±0.3	1	2.0	KTJ101B475M55AFT00	400
	6.8	X7R	2220 / 5750	6.0±0.4	5.3±0.4	5.5	1.3±0.3	2	3.0	KTJ101B685M55BFT00	2,000
	10	X7R	2220 / 5750	6.0±0.4	5.3±0.4	5.5	1.3±0.3	2	3.0	KTJ101B106M55BFT00	2,000
	15	X7R	2220 / 5750	6.0±0.4	5.3±0.4	5.5	1.3±0.3	2	3.0	KTJ101B156M55BFT00	2,000
	22	X7R	2220 / 5750	6.0±0.4	5.3±0.4	5.5	1.3±0.3	2	3.0	KTJ101B226M55BFT00	2,000
	6.8	X7R	3025 / 7563	7.8±0.5	6.6±0.5	5.5	1.5±0.3	1	3.0	KTJ101B685M76AFT00	1,200
	15	X7R	3025 / 7563	7.8±0.5	6.6±0.5	8.5	1.5±0.3	2	4.0	KTJ101B156M76BFT00	500
250	1.0	X7R	2220 / 5750	6.0±0.4	5.3±0.4	3.8	1.3±0.3	1	2.0	KTJ251B105M55AFT00	400
	1.5	X7R	2220 / 5750	6.0±0.4	5.3±0.4	5.5	1.3±0.3	2	3.0	KTJ251B155M55BFT00	2,000
	2.2	X7R	2220 / 5750	6.0±0.4	5.3±0.4	5.5	1.3±0.3	2	3.0	KTJ251B225M55BFT00	2,000
	2.2	X7R	3025 / 7563	7.8±0.5	6.6±0.5	5.5	1.5±0.3	1	3.0	KTJ251B225M76AFT00	1,200
	3.3	X7R	3025 / 7563	7.8±0.5	6.6±0.5	8.5	1.5±0.3	2	3.0	KTJ251B335M76BFT00	500

※ Please consult with us when you consider the rating other than a standard table.

◆PART NUMBERING SYSTEM

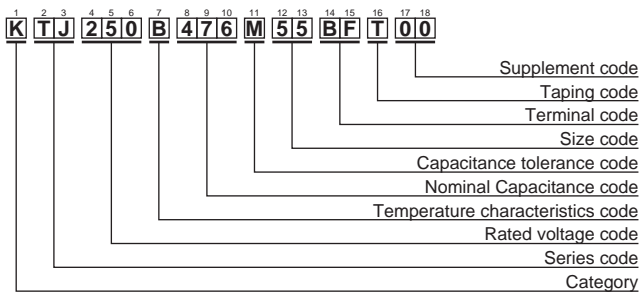

◆DIMENSIONS

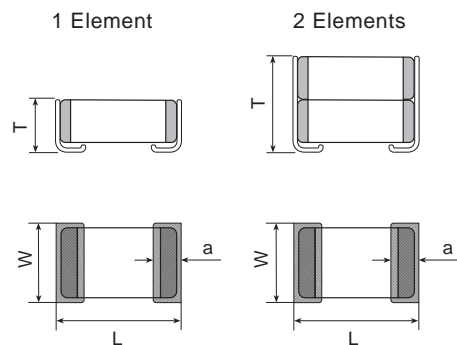

Please refer to "Part Numbering System" of the beginning of a catalog for the details.

KVJ Series



◆FEATURES

1. Automotive grade(AEC-Q200)
2. Small size and large capacitance, high ripple current.
3. Temperature cycle: 1000 cycles.
4. X8L temperature characteristics.
5. For reflow soldering use.
6. Suitable for aluminum substrate.

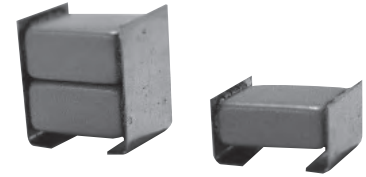

◆APPLICATIONS

1. For automotive equipment
2. Smoothing circuit of switching mode AC-DC or DC-DC converter.
3. On-board power supply.
4. Noise suppressor for various kinds of equipments.

◆CUSTOM MADE PRODUCTS

We can offer custom made one element metal cap type capacitors for request of customers. Please contact us if you have questions for details.

◆CONSTRUCTION

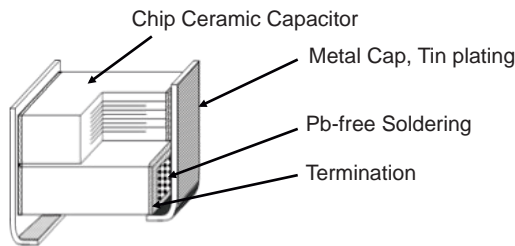

◆RATINGS

1. Category Temperature Range	-55~+150°C
2. Rated Voltage Range	25, 50, 100V _{dc}
3. Rated Capacitance Range	0.68 to 22μF
4. Rated Capacitance Tolerance	M(±20%)
5. Temperature Characteristics	X7R
6. Rated Ripple Current	See No.5 on the following table

◆SPECIFICATIONS

No.	Items	Specification	Test Condition		
1	Withstand Voltage	No abnormality.	250% of rated voltage shall be applied for 5 seconds.		
2	Insulation Resistance	100/C _R (MΩ) or 4000(MΩ) whichever is less.	Rated voltage shall be applied for 60±5 seconds at temperature 25±2°C.		
3	Rated Capacitance	Within specified tolerance.			
			C _R ≤10μF	C _R >10μF	
			Temperature 25±2°C		
4	Dissipation Factor	5.0% maximum	Frequency	1±0.1kHz	120±12Hz
			Voltage	1±0.2V _{rms}	0.5±0.2V _{rms}
5	Rated Ripple Current	See STANDARD RATINGS	10kHz~1MHz (sine curve) Ripple voltage V _p shall be less than the rated voltage.		

As customer requirement, Chemi-Con has submits the test results according to AEC-Q200 for Multilayer ceramic capacitors. Please contact us for more information.

◆SPECIFICATIONS

No.	Items	Specification	Test Condition															
6	Temperature Cycle	Appearance : No visible damage. $\Delta C/C : \pm 15\%$ D.F. : To meet the initial specification. I.R. : To meet the initial specification.	<table border="1"> <thead> <tr> <th>Step</th> <th>Temperature (°C)</th> <th>(min.)</th> </tr> </thead> <tbody> <tr> <td>1</td> <td>Min. Category temperature ± 3</td> <td>30\pm3</td> </tr> <tr> <td>2</td> <td>Room temperature</td> <td>3 max.</td> </tr> <tr> <td>3</td> <td>Max. Category temperature ± 3</td> <td>30\pm3</td> </tr> <tr> <td>4</td> <td>Room temperature</td> <td>3 max.</td> </tr> </tbody> </table> <Cycle> 1000 cycles	Step	Temperature (°C)	(min.)	1	Min. Category temperature ± 3	30 \pm 3	2	Room temperature	3 max.	3	Max. Category temperature ± 3	30 \pm 3	4	Room temperature	3 max.
Step	Temperature (°C)	(min.)																
1	Min. Category temperature ± 3	30 \pm 3																
2	Room temperature	3 max.																
3	Max. Category temperature ± 3	30 \pm 3																
4	Room temperature	3 max.																
7	Humidity Load Life	Appearance : No abnormality. $\Delta C/C : \pm 20\%$ D.F. : 10% max. I.R. : 25/C _R (M Ω) or 1000(M Ω) whichever is less.	Temperature : 85 \pm 3°C Humidity : 80 to 85%RH Voltage : Rated voltage Time : 1000 \pm ₀ ⁴⁸ hours															
8	Endurance	Appearance : No abnormality. $\Delta C/C : \pm 20\%$ D.F. : 10% max. I.R. : 50/C _R (M Ω) or 1000(M Ω) whichever is less.	Temperature : 150 \pm 3°C Voltage : Rated voltage Time : 1000 \pm ₀ ⁴⁸ hours															

*C_R : Rated Capacitance(μ F)

◆Note of mountig for KVJ series.

1. The gap of capacitor and a substrate shall be the mounting face.
2. To prevent degradation of temperature cycling capability, if need to be careful about amount of solder that would not go into the inner side of terminations.

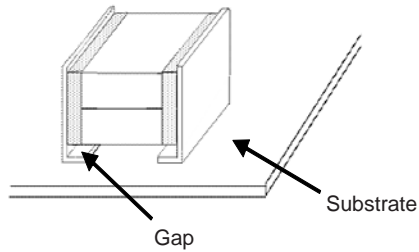

◆ STANDARD RATINGS

Rated voltage (Vdc)	Rated Capacitance (μF)	Electrostatic Capacitance Temperature Characteristics	Case Code	Dimensions(mm)				Element	Maximum ripple current (Arms)	Part Number	Taping Quantity per reel (pcs. / reel)
				inch / mm	L	W	T max.				
25	6.8	X8L	2220 / 5750	6.0±0.4	5.3±0.4	3.8	1.3±0.3	1	2.0	KVJ250L685M55ART00	400
	10	X8L	2220 / 5750	6.0±0.4	5.3±0.4	3.8	1.3±0.3	1	2.0	KVJ250L106M55ART00	400
	15	X8L	2220 / 5750	6.0±0.4	5.3±0.4	5.5	1.3±0.3	2	3.0	KVJ250L156M55BRT00	2,000
	22	X8L	2220 / 5750	6.0±0.4	5.3±0.4	6.0	1.3±0.3	2	3.0	KVJ250L226M55BRT00	2,000
50	2.2	X8L	2220 / 5750	6.0±0.4	5.3±0.4	3.8	1.3±0.3	1	2.0	KVJ500L225M55ART00	400
	3.3	X8L	2220 / 5750	6.0±0.4	5.3±0.4	3.8	1.3±0.3	1	2.0	KVJ500L335M55ART00	400
	4.7	X8L	2220 / 5750	6.0±0.4	5.3±0.4	3.8	1.3±0.3	1	2.0	KVJ500L475M55ART00	400
	6.8	X8L	2220 / 5750	6.0±0.4	5.3±0.4	5.5	1.3±0.3	2	3.0	KVJ500L685M55BRT00	2,000
	10	X8L	2220 / 5750	6.0±0.4	5.3±0.4	6.0	1.3±0.3	2	3.0	KVJ500L106M55BRT00	2,000
100	0.68	X8L	2220 / 5750	6.0±0.4	5.3±0.4	3.8	1.3±0.3	1	2.0	KVJ101L684M55ART00	400
	1.0	X8L	2220 / 5750	6.0±0.4	5.3±0.4	3.8	1.3±0.3	1	2.0	KVJ101L105M55ART00	400
	1.5	X8L	2220 / 5750	6.0±0.4	5.3±0.4	5.5	1.3±0.3	2	3.0	KVJ101L155M55BRT00	2,000
	2.2	X8L	2220 / 5750	6.0±0.4	5.3±0.4	6.0	1.3±0.3	2	3.0	KVJ101L225M55BRT00	2,000

※ Please consult with us when you consider the rating other than a standard table.

◆ PART NUMBERING SYSTEM

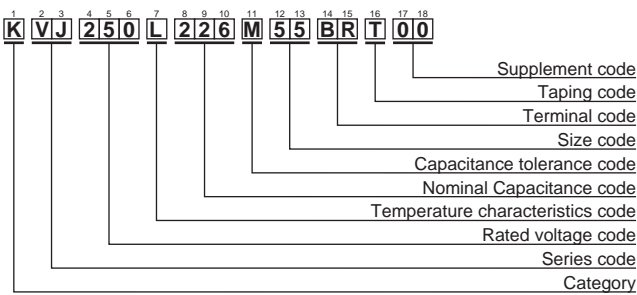

◆ DIMENSIONS

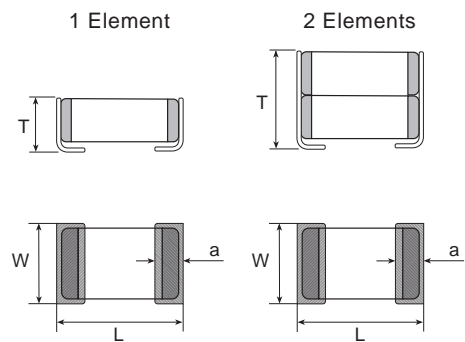

Please refer to "Part Numbering System" of the beginning of a catalog for the details.



DIPPED RADIAL LEAD MULTILAYER CERAMIC CAPACITORS

NTD Series



◆FEATURES

1. Small in size and wide capacitance range.
Max. 470 μ F is available.
2. Temperature characteristic is X7R in EIA code.
3. Superior humidity characteristic and long life.
4. Excellent high frequency characteristic due to low ESR.
5. High rated ripple current.
6. 500V_{dc} items are available.
7. Resin(UL94 V-0) used for coating.
8. Pb-free design(also ceramic dielectric)

◆APPLICATIONS

1. Smoothing circuit of switching mode AC-DC or DC-DC converter.
2. Noise suppressor for various kinds of equipments.
3. By-pass or decoupling circuits.
4. Automotive equipments.

◆CONSTRUCTION

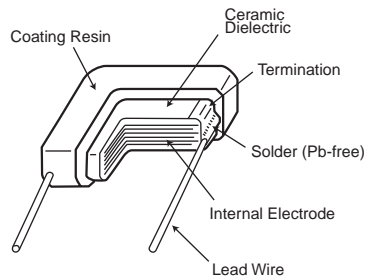

◆RATINGS

1. Category Temperature Range	-55 to +125°C
2. Rated Voltage Range	25, 35, 50, 100, 250, 500V _{dc}
3. Rated Capacitance Range	0.1 to 470 μ F
4. Rated Capacitance Tolerance	M(\pm 20%), K(\pm 10%)
5. Temperature Characteristics	X7R
6. Rated Ripple Current	See No.5 on the following table

◆SPECIFICATIONS

No.	Items		Specification	Test Condition		
1	Withstand Voltage	Between Terminals	No abnormality.	Rated voltage	Withstand voltage	
		Terminals to Coating Resin		Less than 250V	250% of rated voltage	
	More than 250V Less than 500V			100V + 150% of rated voltage		
	More than 500V			130% of rated voltage		
Shall be applied for 5 seconds.						
2	Insulation Resistance		100/C _R (M Ω) or 4000(M Ω) whichever is less.	Rated voltage shall be applied for 60 \pm 5 seconds at temperature 25 \pm 2°C.		
3	Rated Capacitance		Within specified tolerance.		C _R \leq 10 μ F	C _R >10 μ F
				Temperature	25 \pm 2°C	
4	Dissipation Factor		5.0% maximum.	Frequency	1 \pm 0.1kHz	120 \pm 12Hz
				Voltage	1 \pm 0.2V _{rms}	0.5 \pm 0.2V _{rms}

As customer requirement, Chemi-Con has submits the test results according to AEC-Q200 for Multilayer ceramic capacitors. Please contact us for more information.

Product specifications in this catalog are subject to change without notice. Request our product specifications before purchase and/or use. Please use our products based on the information contained in this catalog and product specifications.



DIPPED RADIAL LEAD MULTILAYER CERAMIC CAPACITORS

NTD Series

◆ SPECIFICATIONS

No.	Items	Specification	Test Condition															
5	Rated Ripple Current	See STANDARD RATINGS	10kHz to 1MHz (sine curve) Ripple voltage V_p shall be less than the rated voltage.															
6	Robustness of Terminations	No visible damage.	The force applied shall be : <table border="1"> <thead> <tr> <th>Lead ϕ (mm)</th> <th>Tensile(N)</th> <th>(sec.)</th> </tr> </thead> <tbody> <tr> <td>0.5 max.</td> <td>5</td> <td>10±1</td> </tr> <tr> <td>0.6 min.</td> <td>10</td> <td>10±1</td> </tr> </tbody> </table>	Lead ϕ (mm)	Tensile(N)	(sec.)	0.5 max.	5	10±1	0.6 min.	10	10±1						
	Lead ϕ (mm)		Tensile(N)	(sec.)														
0.5 max.	5	10±1																
0.6 min.	10	10±1																
	Bending		<table border="1"> <thead> <tr> <th>Lead ϕ (mm)</th> <th>Bending(N)</th> <th>(kg)</th> </tr> </thead> <tbody> <tr> <td>0.5 max.</td> <td>2.5</td> <td>0.25</td> </tr> <tr> <td>0.6 min.</td> <td>5</td> <td>0.51</td> </tr> </tbody> </table> Time : 2times.	Lead ϕ (mm)	Bending(N)	(kg)	0.5 max.	2.5	0.25	0.6 min.	5	0.51						
Lead ϕ (mm)	Bending(N)	(kg)																
0.5 max.	2.5	0.25																
0.6 min.	5	0.51																
7	Vibration	Appearance : No abnormality. Capacitance : To meet the initial specification. D.F. : To meet the initial specification.	Amplitude : 1.5mm Frequency range : 10-55-10Hz (1 min) Direction and time : 2 hours each to X, Y, Z axis. Total 6 hours.															
8	Solderability	Min. 75% of surface of the termination shall be covered with new solder.	<table border="1"> <thead> <tr> <th>Solder</th> <th>Pb Free</th> </tr> </thead> <tbody> <tr> <td>Solder Temperature</td> <td>245±5°C</td> </tr> <tr> <td>Dipping Time</td> <td>2±0.5sec.</td> </tr> </tbody> </table>	Solder	Pb Free	Solder Temperature	245±5°C	Dipping Time	2±0.5sec.									
Solder	Pb Free																	
Solder Temperature	245±5°C																	
Dipping Time	2±0.5sec.																	
9	Resistance to Soldering Heat	Appearance : No abnormality. $\Delta C/C : \pm 15\%$ D.F. : To meet the initial specification. I.R. : To meet the initial specification.	Solder Temperature : 350±10°C Dipping Time : 3±0.5 sec. Depth : 1.5 to 2mm															
10	Temperature Cycle	Appearance : No abnormality. $\Delta C/C : \pm 15\%$ D.F. : To meet the initial specification. I.R. : To meet the initial specification.	<table border="1"> <thead> <tr> <th>Step</th> <th>Temperature (°C)</th> <th>(min.)</th> </tr> </thead> <tbody> <tr> <td>1</td> <td>Min. Category temperature ±3</td> <td>30±3</td> </tr> <tr> <td>2</td> <td>Room temperature</td> <td>3 max.</td> </tr> <tr> <td>3</td> <td>Max. Category temperature ±3</td> <td>30±3</td> </tr> <tr> <td>4</td> <td>Room temperature</td> <td>3 max.</td> </tr> </tbody> </table> For 5 cycles for above temperature cycle.	Step	Temperature (°C)	(min.)	1	Min. Category temperature ±3	30±3	2	Room temperature	3 max.	3	Max. Category temperature ±3	30±3	4	Room temperature	3 max.
Step	Temperature (°C)	(min.)																
1	Min. Category temperature ±3	30±3																
2	Room temperature	3 max.																
3	Max. Category temperature ±3	30±3																
4	Room temperature	3 max.																
11	Humidity Load Life	Appearance : No abnormality. $\Delta C/C : \pm 20\%$ D.F. : 10% maximum I.R. : 25/ C_R (M Ω) or 1000(M Ω) whichever is less.	Temperature : 40±2°C Humidity : 90 to 95%RH Voltage : Rated voltage Time : 500± ₀ ²⁴ hours															
12	Endurance	Appearance : No abnormality. $\Delta C/C : \pm 20\%$ D.F. : 10% maximum I.R. : 50/ C_R (M Ω) or 1000(M Ω) whichever is less.	Temperature : 125±3°C Voltage : Rated voltage Time : 1000± ₀ ⁴⁸ hours															

* C_R : Rated Capacitance(μ F)



DIPPED RADIAL LEAD MULTILAYER CERAMIC CAPACITORS

NTD Series

◆ STANDARD RATINGS

Rated voltage (Vdc)	Rated Capacitance (μF)	Electrostatic Capacitance Temperature Characteristics	Dimensions(mm)					Maximum ripple current (Arms)	Part Number	Taping Quantity per reel (pcs. / reel)
			L max.	W max.	T max.	F±0.8	φd±0.05			
25	3.3	X7R	5.0	6.0	3.5	5.0	0.5	0.3	KTD250B335□32A0T00	2,000
	4.7	X7R	5.0	6.0	3.5	5.0	0.5	0.3	KTD250B475□32A0T00	2,000
	6.8	X7R	6.5	6.5	4.0	5.0	0.5	0.8	KTD250B685□43A0T00	2,000
	10	X7R	6.5	6.5	4.0	5.0	0.5	0.8	KTD250B106□43A0T00	2,000
	15	X7R	6.5	6.5	4.0	5.0	0.5	0.8	KTD250B156□43A0T00	2,000
	15	X7R	7.5	9.0	4.5	5.0	0.5	1.0	KTD250B156□55A0T00	2,000
	22	X7R	7.5	9.0	4.5	5.0	0.5	1.0	KTD250B226□55A0T00	2,000
	33	X7R	7.5	9.0	4.5	5.0	0.5	1.0	KTD250B336□55A0T00	2,000
	47	X7R	10.0	11.5	5.5	5.0	0.5	1.5	KTD250B476□76A0T00	1,000
	68	X7R	13.5	15.0	6.0	10.0	0.6	2.0	KTD250B686M80A0B00	—
	100	X7R	13.5	15.0	8.0	10.0	0.6	2.0	KTD250B107M80A0B00	—
	150	X7R	22.5	20.0	6.0	20.0	0.8	3.0	KTD250B157M90A0B00	—
220	X7R	22.5	20.0	8.0	20.0	0.8	3.0	KTD250B227M90A0B00	—	
330	X7R	28.5	20.0	8.0	25.0	0.8	4.0	KTD250B337M99A0B00	—	
470	X7R	28.5	20.0	11.5	25.0	0.8	4.0	KTD250B477M99A0B00	—	
35	3.3	X7R	5.0	6.0	3.5	5.0	0.5	0.3	KTD350B335□32A0T00	2,000
	4.7	X7R	5.0	6.0	3.5	5.0	0.5	0.3	KTD350B475□32A0T00	2,000
	6.8	X7R	6.5	6.5	4.0	5.0	0.5	0.8	KTD350B685□43A0T00	2,000
	10	X7R	6.5	6.5	4.0	5.0	0.5	0.8	KTD350B106□43A0T00	2,000
	15	X7R	7.5	9.0	4.5	5.0	0.5	1.0	KTD350B156□55A0T00	2,000
	22	X7R	7.5	9.0	4.5	5.0	0.5	1.0	KTD350B226□55A0T00	2,000
	33	X7R	10.0	11.5	5.0	5.0	0.5	1.5	KTD350B336□76A0T00	1,000
47	X7R	10.0	11.5	5.5	5.0	0.5	1.5	KTD350B476□76A0T00	1,000	
50	1.0	X7R	5.0	6.0	3.5	5.0	0.5	0.3	KTD500B105□32A0T00	2,000
	1.5	X7R	5.0	6.0	3.5	5.0	0.5	0.3	KTD500B155□32A0T00	2,000
	2.2	X7R	5.0	6.0	3.5	5.0	0.5	0.3	KTD500B225□32A0T00	2,000
	3.3	X7R	5.0	6.0	3.5	5.0	0.5	0.3	KTD500B335□32A0T00	2,000
	4.7	X7R	6.5	6.5	4.0	5.0	0.5	0.8	KTD500B475□43A0T00	2,000
	6.8	X7R	6.5	6.5	4.0	5.0	0.5	0.8	KTD500B685□43A0T00	2,000
	10	X7R	7.5	9.0	4.5	5.0	0.5	1.0	KTD500B106□55A0T00	2,000
	15	X7R	7.5	9.0	4.5	5.0	0.5	1.0	KTD500B156□55A0T00	2,000
	22	X7R	10.0	11.5	5.0	5.0	0.5	1.5	KTD500B226□76A0T00	1,500
	33	X7R	13.5	15.0	5.5	10.0	0.6	2.0	KTD500B336M80A0B00	—
	47	X7R	22.5	20.0	6.0	20.0	0.8	3.0	KTD500B476M90A0B00	—
	68	X7R	22.5	20.0	6.0	20.0	0.8	3.0	KTD500B686M90A0B00	—
	100	X7R	22.5	20.0	6.0	20.0	0.8	3.0	KTD500B107M90A0B00	—
	150	X7R	28.5	20.0	7.5	25.0	0.8	4.0	KTD500B157M99A0B00	—
220	X7R	28.5	20.0	10.0	25.0	0.8	4.0	KTD500B227M99A0B00	—	
100	0.33	X7R	5.0	6.0	3.5	5.0	0.5	0.3	KTD101B334□32A0T00	2,000
	0.47	X7R	5.0	6.0	3.5	5.0	0.5	0.3	KTD101B474□32A0T00	2,000
	0.68	X7R	5.0	6.0	3.5	5.0	0.5	0.3	KTD101B684□32A0T00	2,000
	1.0	X7R	5.0	6.0	3.5	5.0	0.5	0.3	KTD101B105□32A0T00	2,000
	1.5	X7R	5.0	6.0	3.5	5.0	0.5	0.3	KTD101B155□32A0T00	2,000
	2.2	X7R	5.0	6.0	3.5	5.0	0.5	0.3	KTD101B225□32A0T00	2,000
	1.5	X7R	6.5	6.5	4.0	5.0	0.5	0.8	KTD101B155□43A0T00	2,000
	2.2	X7R	6.5	6.5	4.0	5.0	0.5	0.8	KTD101B225□43A0T00	2,000
	3.3	X7R	6.5	6.5	4.0	5.0	0.5	0.8	KTD101B335□43A0T00	2,000
	4.7	X7R	6.5	6.5	4.0	5.0	0.5	0.8	KTD101B475□43A0T00	2,000
	3.3	X7R	7.5	9.0	4.5	5.0	0.5	1.0	KTD101B335□55A0T00	2,000
	4.7	X7R	7.5	9.0	4.5	5.0	0.5	1.0	KTD101B475□55A0T00	2,000
	6.8	X7R	7.5	9.0	4.7	5.0	0.5	1.0	KTD101B685□55A0T00	2,000
	6.8	X7R	10.0	11.5	5.0	5.0	0.5	1.5	KTD101B685□76A0T00	1,500
	10	X7R	13.5	15.0	5.0	10.0	0.6	2.0	KTD101B106M80A0B00	—
	15	X7R	13.5	15.0	6.0	10.0	0.6	2.0	KTD101B156M80A0B00	—
	22	X7R	22.5	20.0	6.0	20.0	0.8	3.0	KTD101B226M90A0B00	—
	33	X7R	22.5	20.0	6.0	20.0	0.8	3.0	KTD101B336M90A0B00	—
	47	X7R	28.5	20.0	7.5	25.0	0.8	4.0	KTD101B476M99A0B00	—
	68	X7R	28.5	20.0	7.5	25.0	0.8	4.0	KTD101B686M99A0B00	—
100	X7R	28.5	20.0	9.0	25.0	0.8	4.0	KTD101B107M99A0B00	—	

NTD Series

◆ STANDARD RATINGS

Rated voltage (Vdc)	Rated Capacitance (μF)	Electrostatic Capacitance Temperature Characteristics	Dimensions(mm)					Maximum ripple current (Arms)	Part Number	Taping Quantity per reel (pcs. / reel)
			L max.	W max.	T max.	F±0.8	φd±0.05			
250	0.1	X7R	5.0	6.0	3.5	5.0	0.5	0.3	KTD251B104□32A0T00	2,000
	0.15	X7R	5.0	6.0	3.5	5.0	0.5	0.3	KTD251B154□32A0T00	2,000
	0.22	X7R	5.0	6.0	3.5	5.0	0.5	0.3	KTD251B224□32A0T00	2,000
	0.33	X7R	5.0	6.0	3.5	5.0	0.5	0.3	KTD251B334□32A0T00	2,000
	0.47	X7R	6.5	6.5	4.0	5.0	0.5	0.8	KTD251B474□43A0T00	2,000
	0.68	X7R	6.5	6.5	4.0	5.0	0.5	0.8	KTD251B684□43A0T00	2,000
	1.0	X7R	7.5	9.0	4.5	5.0	0.5	1.0	KTD251B105□55A0T00	2,000
	1.5	X7R	7.5	9.0	4.5	5.0	0.5	1.0	KTD251B155□55A0T00	2,000
	2.2	X7R	10.0	11.5	6.0	5.0	0.5	1.5	KTD251B225□76A0T00	1,000
	2.2	X7R	13.5	15.0	5.0	10.0	0.6	2.0	KTD251B225M80A0B00	—
	3.3	X7R	22.5	20.0	6.0	20.0	0.8	3.0	KTD251B335M90A0B00	—
	4.7	X7R	22.5	20.0	6.0	20.0	0.8	3.0	KTD251B475M90A0B00	—
500	0.47	X7R	7.5	9.0	3.5	5.0	0.5	0.8	KTD501B474□55A0T00	2,000
	0.56	X7R	7.5	9.0	3.5	5.0	0.5	0.8	KTD501B564□55A0T00	2,000
	0.68	X7R	10.0	11.5	3.4	5.0	0.5	1.0	KTD501B684□76A0T00	1,500
	1.0	X7R	10.0	11.5	3.8	5.0	0.5	1.0	KTD501B105□76A0T00	1,500
	1.2	X7R	10.0	11.5	4.2	5.0	0.5	1.0	KTD501B125□76A0T00	1,500

※ The square (□) in part numbers is replaced by a capacitance tolerance code: 'K' when ±10%, or 'M' when ±20%
 ※ Please consult with us when you consider the rating other than a standard table.

◆ PART NUMBERING SYSTEM

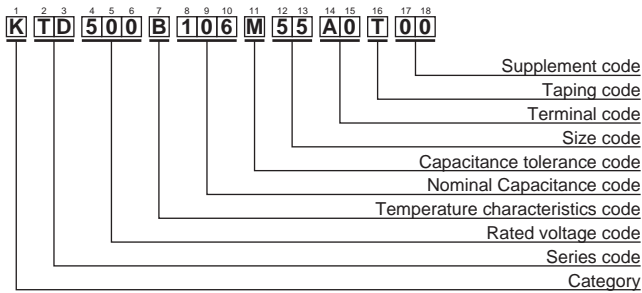

◆ DIMENSIONS

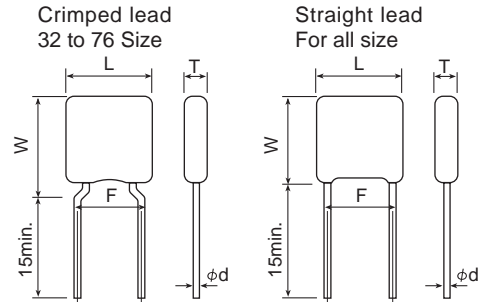

Please refer to "Part Numbering System" of the beginning of a catalog for the details.

◆FEATURES

1. Temperature range : -55 to +150°C
2. Temperature characteristic : X8L
3. Small in size and wide capacitance range.
Max. 15μF is available.
4. Epoxy resin(UL94 V-0)used for coating.
5. Automotive grade(AEC-Q200)

◆APPLICATIONS

1. Noise filter for automotive equipment(ECU etc.)
2. Equipment used in a high temperature environment

◆CONSTRUCTION

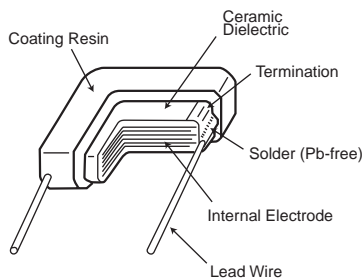

◆RATINGS

1. Category Temperature Range	-55~+150°C
2. Rated Voltage Range	25, 50, 100 Vdc
3. Rated Capacitance Range	0.1~15μF
4. Rated Capacitance Tolerance	M(±20%), K(±10%)
5. Temperature Characteristics	X8L
6. Rated Ripple Current	See No.5 on the following table

◆SPECIFICATIONS

No.	Items		Specification	Test Condition	
1	Withstand Voltage	Between Terminals	No abnormality.	250% of rated voltage shall be applied for 5 seconds. (Only 250V _{dc} products : 475V)	
		Terminals to Coating Resin			
2	Insulation Resistance		100/C _R (MΩ) or 4000(MΩ) whichever is less.	Rated voltage shall be applied for 60±5 seconds at temperature 25±2°C.	
3	Rated Capacitance		Within specified tolerance.		CR≤10μF
					CR>10μF
				Temperature	25±2°C
4	Dissipation Factor		5.0% maximum.	Frequency	1±0.1kHz 120±12Hz
				Voltage	1±0.2Vrms 0.5±0.2Vrms

As customer requirement, Chemi-Con has submits the test results according to AEC-Q200 for Multilayer ceramic capacitors. Please contact us for more information.



DIPPED RADIAL LEAD MULTILAYER CERAMIC CAPACITORS

KVD Series

◆ SPECIFICATIONS

No.	Items	Specification	Test Condition															
5	Rated Ripple Current	<table border="1"> <tr> <td>Size code</td> <td>32</td> <td>43</td> <td>55</td> </tr> <tr> <td>Arms</td> <td>0.3</td> <td>0.8</td> <td>1.0</td> </tr> </table>	Size code	32	43	55	Arms	0.3	0.8	1.0	10kHz to 1MHz (sine curve) Ripple voltage V_p shall be less than the rated voltage. The surface temperature of MLCC must not exceed the maximum category temperature when the ripple current is applied.							
Size code	32	43	55															
Arms	0.3	0.8	1.0															
6	High Temperature Exposure(Storage)	Appearance : No structural damage such as cracks $\Delta C/C : \pm 20\%$ D.F. : 10% maximum I.R. : $50/C_R(M\Omega)$ or $1000(M\Omega)$ whichever is less.	Temperature : Max. category temperature $\pm 3^\circ C$ Time : 1000 ± 48 hours															
7	Temperature Cycle	Appearance : No visible damage. $\Delta C/C : \pm 15\%$ D.F. : To meet the initial specification. I.R. : To meet the initial specification.	<table border="1"> <thead> <tr> <th>Step</th> <th>Temperature($^\circ C$)</th> <th>(min)</th> </tr> </thead> <tbody> <tr> <td>1</td> <td>Min Category temperature ± 3</td> <td>30 ± 3</td> </tr> <tr> <td>2</td> <td>Room temperature</td> <td>3 max.</td> </tr> <tr> <td>3</td> <td>Max. Category temperature ± 3</td> <td>30 ± 3</td> </tr> <tr> <td>4</td> <td>Room temperature</td> <td>3 max.</td> </tr> </tbody> </table> For 1000 cycles	Step	Temperature($^\circ C$)	(min)	1	Min Category temperature ± 3	30 ± 3	2	Room temperature	3 max.	3	Max. Category temperature ± 3	30 ± 3	4	Room temperature	3 max.
Step	Temperature($^\circ C$)	(min)																
1	Min Category temperature ± 3	30 ± 3																
2	Room temperature	3 max.																
3	Max. Category temperature ± 3	30 ± 3																
4	Room temperature	3 max.																
8	Biased Humidity	Appearance : No abnormality. $\Delta C/C : \pm 20\%$ D.F. : 10% maximum I.R. : $25/C_R(M\Omega)$ or $1000(M\Omega)$ whichever is less.	Temperature : $85^\circ C \pm 3^\circ C$ Humidity : $80 \sim 85\%RH$ Voltage : Rated voltage Time : 1000 ± 48 hours															
9	Operational Life	Appearance : No structural damage such as cracks $\Delta C/C : \pm 20\%$ D.F. : 10% maximum I.R. : $50/C_R(M\Omega)$ or $1000(M\Omega)$ whichever is less.	Temperature : Max. category temperature $\pm 3^\circ C$ Voltage : Rated voltage Time : 1000 ± 48 hours															
10	Terminal Strength (Leaded)	<table border="1"> <tr> <td>Tension</td> <td rowspan="2">No visible damage.</td> </tr> <tr> <td>Bending</td> </tr> </table>	Tension	No visible damage.	Bending	The force applied shall be : <table border="1"> <tr> <th>Lead ϕ (mm)</th> <th>Tensile(N)</th> <th>(sec.)</th> </tr> <tr> <td>0.5 max.</td> <td>5</td> <td>10 ± 1</td> </tr> </table> <table border="1"> <tr> <th>Lead ϕ (mm)</th> <th>Bending(N)</th> <th>(kg)</th> </tr> <tr> <td>0.5 max.</td> <td>2.5</td> <td>0.25</td> </tr> </table> Time : 2times.	Lead ϕ (mm)	Tensile(N)	(sec.)	0.5 max.	5	10 ± 1	Lead ϕ (mm)	Bending(N)	(kg)	0.5 max.	2.5	0.25
Tension	No visible damage.																	
Bending																		
Lead ϕ (mm)	Tensile(N)	(sec.)																
0.5 max.	5	10 ± 1																
Lead ϕ (mm)	Bending(N)	(kg)																
0.5 max.	2.5	0.25																
11	Mechanical Shock	Appearance : No abnormality. $\Delta C/C : \pm 20\%$ D.F. : To meet the initial specification.	MIL-STD-202 Method 213 Condition C Peak value : 100G Normal duration : 6 ms Velocity change : 12.3 ft/sec(3.8m/s) Direction and time : 3 times each in X,Y, Z axis. Total 18 times															
12	Vibration	Appearance : No abnormality. $\Delta C/C : \pm 20\%$ D.F. : To meet the initial specification.	MIL-STD-202 Method 204 Test condition : 5G peak Amplitude : 1.5mm max. Frequency : 10-2000-10Hz(20 minute) Direction and time : 12 times each in X,Y, Z axis. Total 36 times															
13	Resistance to Soldering Heat	Appearance : No visible damage. $\Delta C/C : \pm 15\%$ D.F. : To meet the initial specification. I.R. : To meet the initial specification.	Solder temp. : $260 \pm 5^\circ C$ Dipping Time : $10 \pm 1s$ Depth : 1.5 to 2mm															
14	ESD	Appearance : No abnormality. $\Delta C/C : \pm 20\%$ D.F. : To meet the initial specification. I.R. : To meet the initial specification.	AEC-Q200-002 Connection : Between terminals Direct Contact : 8kV(150pF 2000 Ω) Times : ± 1 time															
15	Solderability	Min. 75% of surface of the termination shall be covered with new solder.	<table border="1"> <tr> <td>Solder</td> <td>Pb Free</td> </tr> <tr> <td>Solder Temperature</td> <td>$245 \pm 5^\circ C$</td> </tr> <tr> <td>Dipping Time</td> <td>$2 \pm 0.5s$</td> </tr> </table>	Solder	Pb Free	Solder Temperature	$245 \pm 5^\circ C$	Dipping Time	$2 \pm 0.5s$									
Solder	Pb Free																	
Solder Temperature	$245 \pm 5^\circ C$																	
Dipping Time	$2 \pm 0.5s$																	

*CR : Rated Capacitance(μF)

◆ STANDARD RATINGS

Rated voltage (Vdc)	Rated Capacitance (μF)	Electrostatic Capacitance Temperature Characteristics	Dimensions(mm)					Maximum ripple current (Arms)	Part Number	Taping Quantity per reel (pcs./reel)
			L max.	W max.	T max.	F±0.8	φd±0.05			
25	1.0	X8L	5.0	6.0	3.5	5.0	0.5	0.3	KVD250L105□32A0T00	2,000
	1.5	X8L	5.0	6.0	3.5	5.0	0.5	0.3	KVD250L155□32A0T00	2,000
	2.2	X8L	5.0	6.0	3.5	5.0	0.5	0.3	KVD250L225□32A0T00	2,000
	3.3	X8L	5.0	6.0	3.5	5.0	0.5	0.3	KVD250L335□32A0T00	2,000
	4.7	X8L	6.5	6.5	4.0	5.0	0.5	0.8	KVD250L475□43A0T00	2,000
	6.8	X8L	6.5	6.5	4.0	5.0	0.5	0.8	KVD250L685□43A0T00	2,000
	10	X8L	7.5	9.0	4.5	5.0	0.5	1.0	KVD250L106□55A0T00	2,000
50	0.33	X8L	5.0	6.0	3.5	5.0	0.5	0.3	KVD500L334□32A0T00	2,000
	0.47	X8L	5.0	6.0	3.5	5.0	0.5	0.3	KVD500L474□32A0T00	2,000
	0.68	X8L	5.0	6.0	3.5	5.0	0.5	0.3	KVD500L684□32A0T00	2,000
	1.0	X8L	5.0	6.0	3.5	5.0	0.5	0.3	KVD500L105□32A0T00	2,000
	1.5	X8L	6.5	6.5	4.0	5.0	0.5	0.8	KVD500L155□43A0T00	2,000
	2.2	X8L	6.5	6.5	4.0	5.0	0.5	0.8	KVD500L225□43A0T00	2,000
	3.3	X8L	7.5	9.0	4.5	5.0	0.5	1.0	KVD500L335□55A0T00	2,000
	4.7	X8L	7.5	9.0	4.5	5.0	0.5	1.0	KVD500L475□55A0T00	2,000
100	0.10	X8L	5.0	6.0	3.5	5.0	0.5	0.3	KVD101L104□32A0T00	2,000
	0.15	X8L	5.0	6.0	3.5	5.0	0.5	0.3	KVD101L154□32A0T00	2,000
	0.22	X8L	5.0	6.0	3.5	5.0	0.5	0.3	KVD101L224□32A0T00	2,000
	0.33	X8L	5.0	6.0	3.5	5.0	0.5	0.3	KVD101L334□32A0T00	2,000
	0.47	X8L	6.5	6.5	4.0	5.0	0.5	0.8	KVD101L474□43A0T00	2,000
	0.68	X8L	6.5	6.5	4.0	5.0	0.5	0.8	KVD101L684□43A0T00	2,000
	1.0	X8L	7.5	9.0	4.5	5.0	0.5	1.0	KVD101L105□55A0T00	2,000
	1.5	X8L	7.5	9.0	4.5	5.0	0.5	1.0	KVD101L155□55A0T00	2,000

※ The square (□) in part numbers is replaced by a capacitance tolerance code: 'K' when ±10%, or 'M' when ±20%
 ※ Please consult with us when you consider the rating other than a standard table.

◆ PART NUMBERING SYSTEM

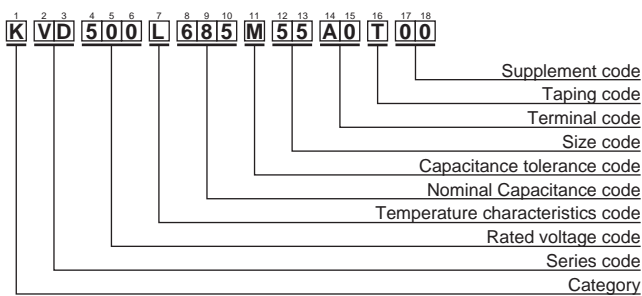

◆ DIMENSIONS

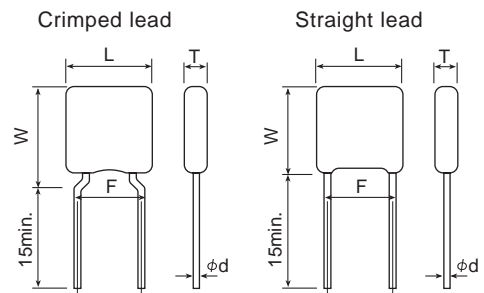

Please refer to "Part Numbering System" of the beginning of a catalog for the details.

◆ Temperature and DC voltage Characteristics

● NTS/NTF/NTD/NTJ series (X7R) 25V

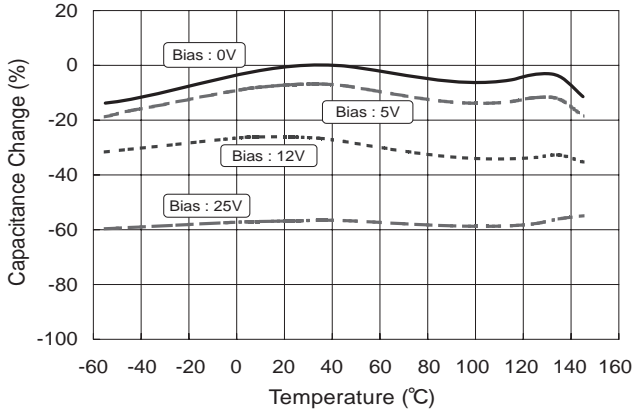

● NTS/NTF/NTD/NTJ series (X7R) 35V

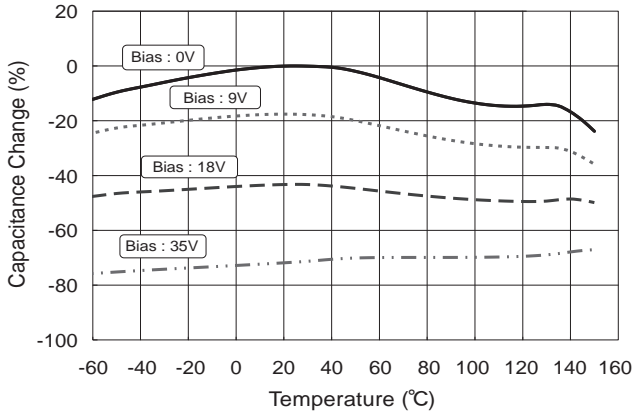

● NTS/NTF/NTD/NTJ series (X7R) 50V

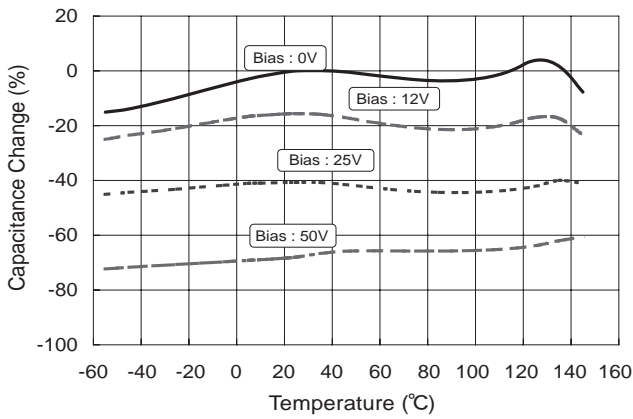

◆ Frequency Characteristics

● NTS Series 25V/33μF

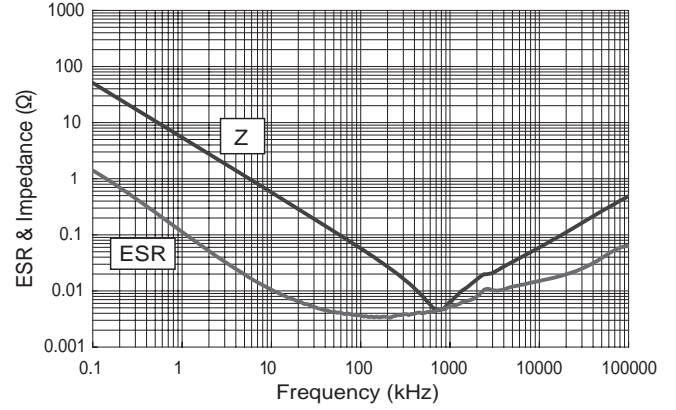

● NTS Series 35V/22μF

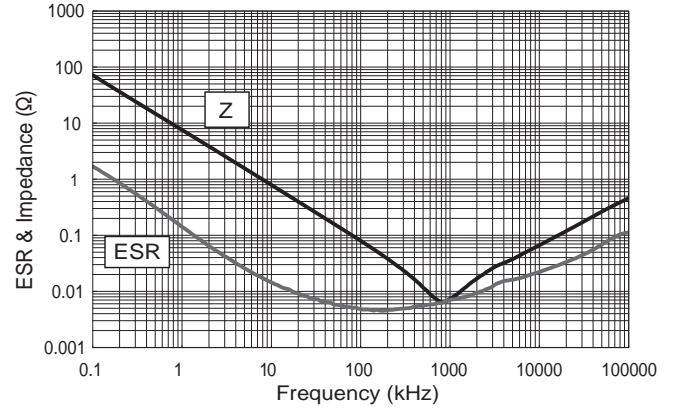

● NTS Series 50V/15μF

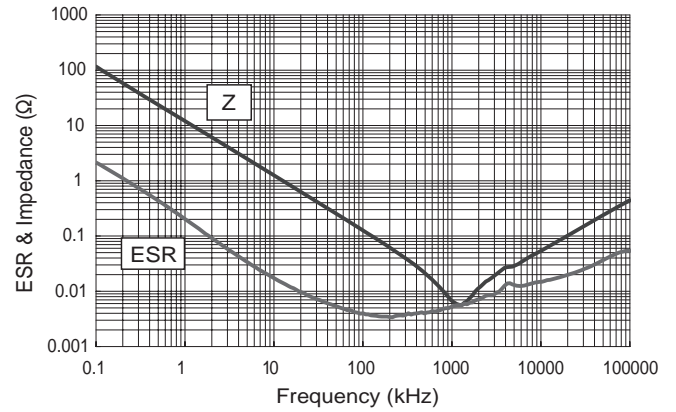

◆ Temperature and DC voltage Characteristics

● NTS/NTF/NTD/NTJ series (X7R) 100V

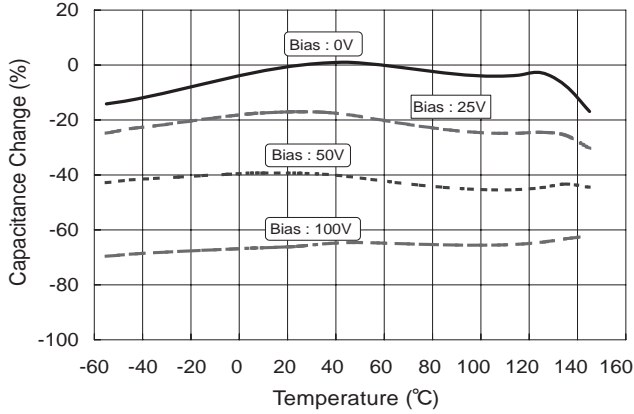

● NTS/NTF/NTD/NTJ series (X7R) 250V

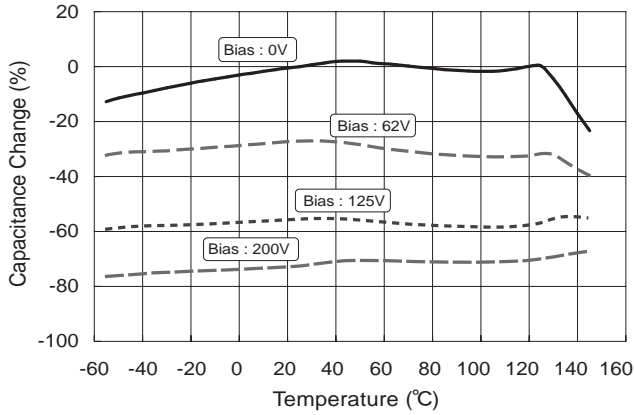

● NTS/NTF/NTD/NTJ Series (X7R) 500V

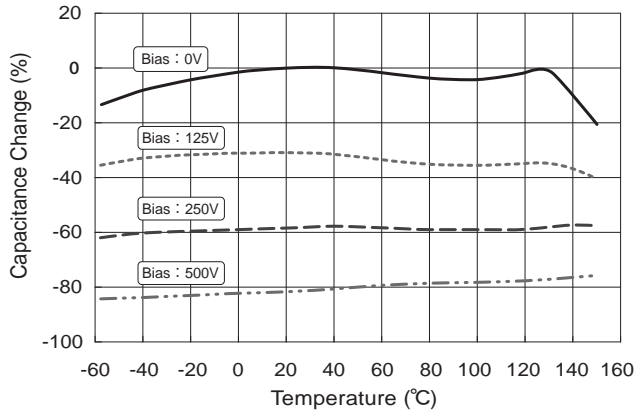

◆ Frequency Characteristics

● NTS Series 100V/6.8μF

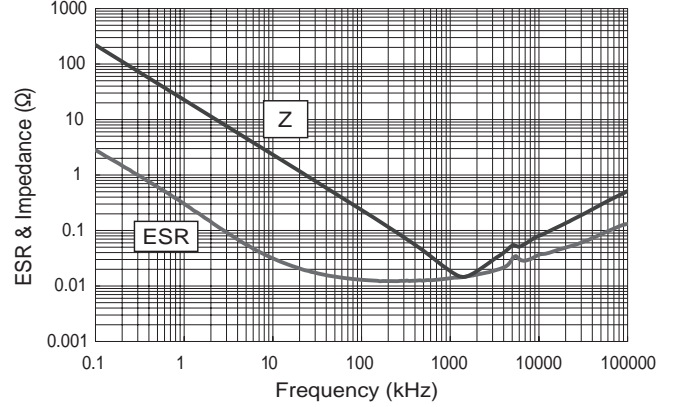

● NTS Series 250V/1.0μF

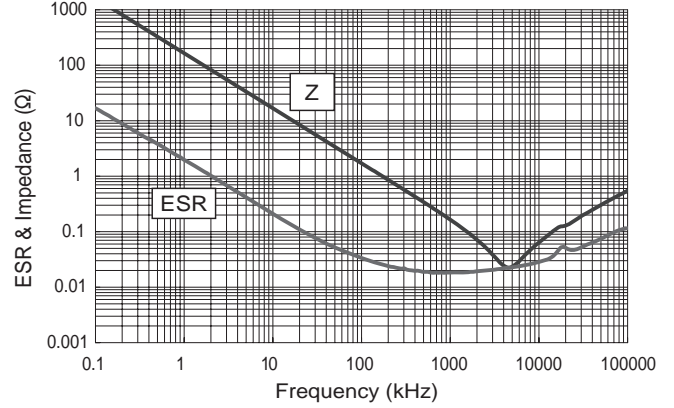

● NTS Series (X7R) 500V/1.2μF

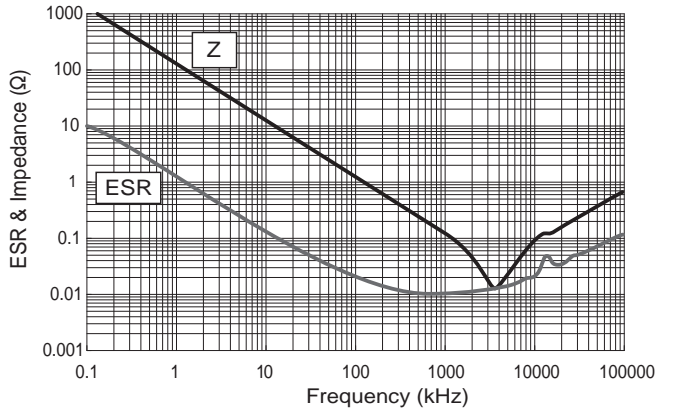

◆ Temperature and DC voltage Characteristics

●KVF/KVD series (X8L) 25V

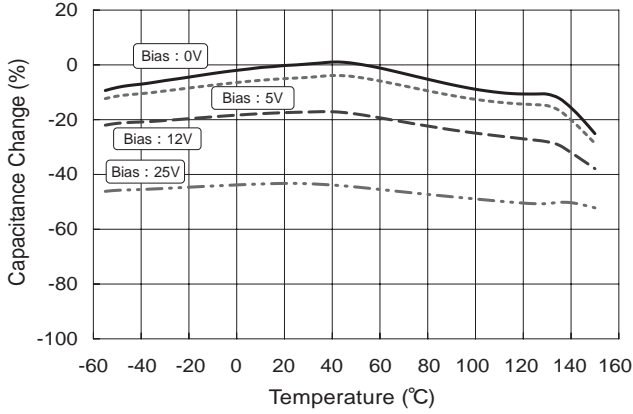

●KVF/KVD series (X8L) 50V

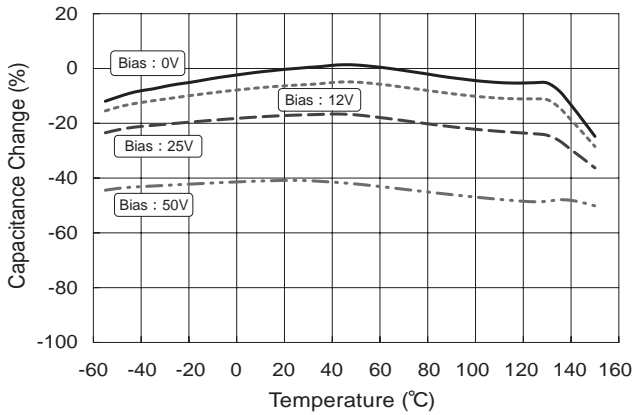

●KVF/KVD series (X8L) 100V

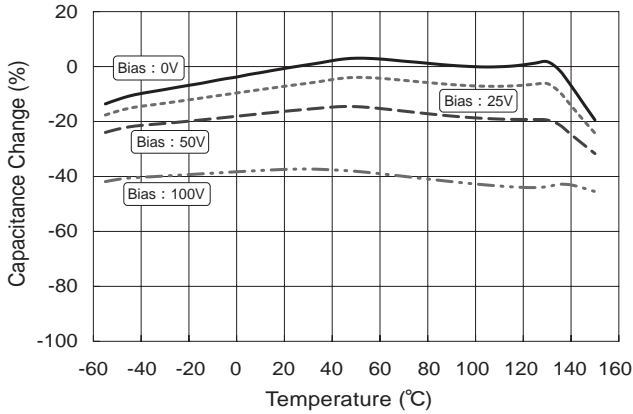

◆ Frequency Characteristics

●KVF Series 25V/1.5μF

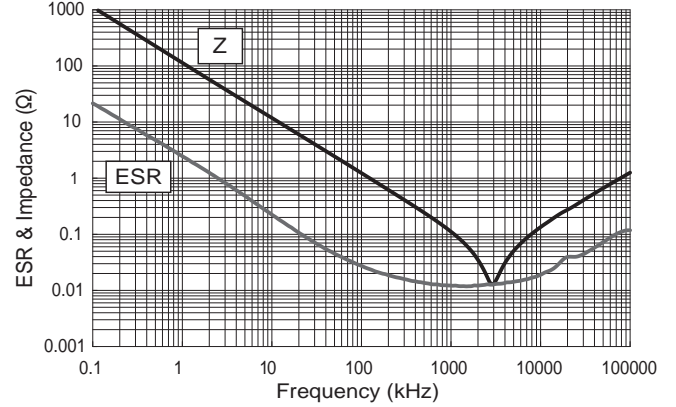

●KVF Series 50V/1.0μF

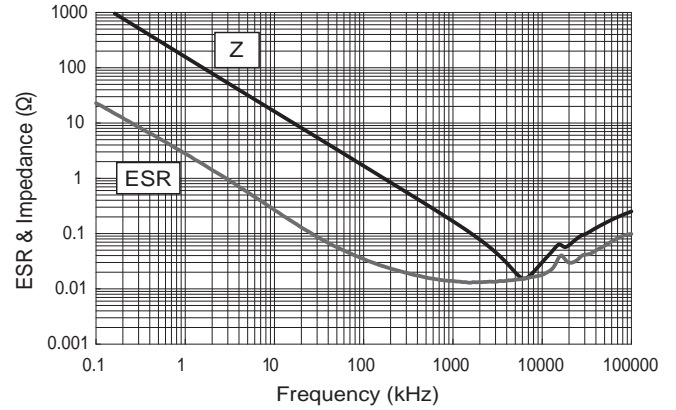

●KVF Series 100V/0.22μF

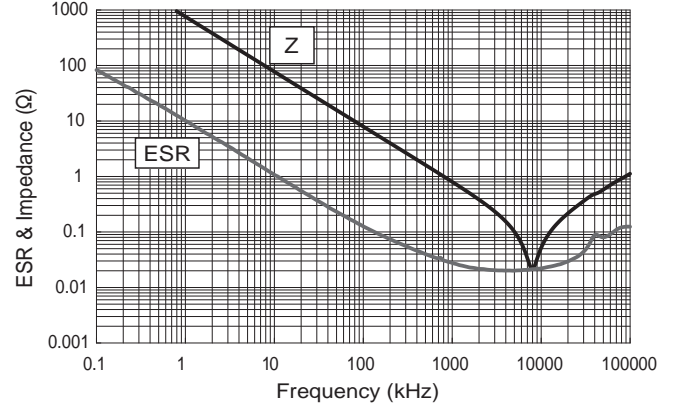

NIPPON CHEMI-CON CORPORATION

	TEL	FAX
JAPAN		
■ NIPPON CHEMI-CON CORPORATION ● Head office: 5-6-4 Osaki, Shinagawa-ku, Tokyo 141-8605, Japan		
	81(3)5436-7711	81(3)5436-7631
U.S.A		
■ UNITED CHEMI-CON, INC. ● Main Office: Continental Towers, 1701 Golf Road 1-1200, Rolling Meadows, Illinois, 60008, U.S.A. ● Buena Park Office: 5651 Dolly Avenue, Buena Park, California, 90621, U.S.A. ● Huntsville Office: South Park Office Center, 7501 Memorial Parkway SW, Suite 209, Huntsville, Alabama, 35801, U.S.A.		
	1(847)696-2000	1(847)696-9278
	1(714)255-9500	1(714)256-1328
	1(256)489-9385	1(256)489-9387
EUROPE		
■ EUROPE CHEMI-CON (DEUTSCHLAND) GmbH Hamburger Strasse 62, D-90451 Nuremberg, Germany		
	49(911)9634-0	49(911)9634-260
KOREA		
■ CHEMI-CON ELECTRONICS (KOREA) CO.,LTD. Room#302, Lotte IT Castle 2nd Block, 550-1, Gasan-dong, Geumcheon-gu, Seoul 08506, Korea		
	82(2)2082-6082	82(2)2082-6084
TAIWAN		
■ TAIWAN CHEMI-CON CORPORATION ● Taipei Office: 5F, No.38, Bo-Ai Road, Chung-Cheng District, Taipei, Taiwan, R.O.C. 100001		
	886(2)2311-6556	886(2)2371-9695
CHINA / HONG KONG		
■ SHANGHAI CHEMI-CON TRADING CO., LTD. ● Shanghai Office: Room18E, New Hua Lian Mansion East Bldg, No.755, Huai Hai Mid Road, Shanghai, China 200020 ● Dalian Branch: Rm 2205, Dalian Gold Name Commercial Tower, 68 Renmin Rd. Zhongshan Dist, Dalian, China 116001 ● Beijing Branch: Rm 905, Towercrest Plaza, No.3 Maizidian West Road, Chaoyang District, Beijing, China 100016		
	86(21)64454588	86(21)64455368
	86(411)82735595	86(411)82739020
	86(10)51087377	86(10)51087378
■ CHEMI-CON TRADING (SHENZHEN) CO., LTD. Rm 1617, NO.1777, Chuangye Road, Hisense Southern Building, Nanshan District, Shenzhen, China 518054		
	86(755)8347-6810	86(755)8347-6820
■ HONG KONG CHEMI-CON LTD. Room 2101, 21/F, Chinachem Exchange Square, 1 Hoi Wan Street, Quarry Bay, Hong Kong		
	852(2527)-3066	852(2865)-1415
ASEAN		
■ CHEMI-CON ELECTRONICS (THAILAND) CO., LTD. 183 Regent House Floor 14th Rajdamri Road, Lumpini, Pathumwan, Bangkok 10330 Thailand		
	66(2651)9782	66(2651)9784
■ SINGAPORE CHEMI-CON (PTE.) LTD. 108 Pasir Panjang Road, #04-08/09 Golden Agri Plaza, Singapore 118535		
	65(6268)2233	65(6509)0344
■ CHEMI-CON (MALAYSIA) SDN,BHD. ● Main Office: FIZ Telok Panglima Garang, Km15, Jalan Klang- Banting, 42507 Kuala Langat, Selangor, Darul Ehsan, Malaysia ● Sales Office: Unit 3A-3A, 3A Floor, Wisma LEADER No.8, Jalan Larut, 10050 Penang, Malaysia		
	60(3)31226239	60(3)31226292
	60(4)2297631	60(4)2291779
■ P.T. INDONESIA CHEMI-CON EJIP Industrial Park Plot 4C Cikarang Selatan, Bekasi 17550, Indonesia		
	62(21)8970070	62(21)8970071

* Specifications in this catalog are subject to change without notice.

ELECTRONIC COMPONENTS & DEVICES

PRODUCTS

	CAT.No.
Aluminum Electrolytic Capacitors	1001
Multilayer Ceramic Capacitors	1002
Film Capacitors	1003
Metal Oxide Varistors TNR™	1006
Nanocrystalline / Amorphous / Dust Choke Coils	1008
Electric Double Layer Capacitors	1009
Camera Modules	

Notes on Safety



- Always read "Notes on Use" before using the product in order to enable you to use the product correctly and prevent any faults and accidents from occurring.
- Request the Product Specification on the product of NIPPON CHEMI-CON CORPORATION to refer to it as well as this brochure prior to the order of the products. Some specific notes on use of the ordered product may be described in the specifications.
- The products listed in this catalog are designed and manufactured for general electronics equipment use and are not intended for use in applications that can adversely affect human life; where the malfunction of equipment may cause damage to life or property. In addition, our products are not intended to be used in specific applications that may cause a major social impact. Please consult with us in advance of usage of our products in the following listed applications. ① Aerospace equipment ② Power generation equipment such as thermal power, nuclear power etc. ③ Medical equipment ④ Transport equipment (automobiles, trains, ships, etc.) ⑤ Transportation control equipment ⑥ Disaster prevention/crime prevention equipment ⑦ Highly publicized information processing equipment ⑧ Submarine equipment ⑨ Other applications that are not considered general-purpose applications.
- The circuits described as examples in this catalog and the "delivery specifications" are featured in order to show the operations and usage of our products, however, this fact does not guarantee that the circuits are available to function in your equipment systems. We are not in any case responsible for any failures or damage caused by the use of information contained herein. You should examine our products, of which the characteristics are described in the "delivery specifications" and other documents, and determine whether or not our products suit your requirements according to the specifications of your equipment systems. Therefore, you bear final responsibility regarding the use of our products. Please make sure that you take appropriate safety measures such as use of redundant design and malfunction prevention measures in order to prevent fatal accidents and/or fires in the event any of our products malfunction.

Note

- We strongly recommend our customers to purchase Nippon Chemi-Con products only through our official sales channels. We assume no responsibility for any defects or damages caused by using products purchased from outside our official sales channel or of counterfeit goods. In addition, we will ask the customer to pay the investigation cost for products purchased outside our official sales channel.
- We reserve the right to discontinue production and delivery of products. We do not guarantee that all the products included in this catalog will be available in the future.
The aforementioned does not apply in the case of individual agreements deviating from the foregoing for customer-specific products
- We continually strive to improve the quality and reliability of our products, but in any case that our product does not meet our published specifications, please stop using it promptly and contact us immediately. As for compensation for non-conforming goods delivered by Chemi-Con, we will limit it only to goods found in non-compliance of our published specifications. This may be accomplished by a no cost replacement of non-conforming individual products, a credit of the piece price paid per each individual non-conforming product, or in other ways deemed necessary.
In addition, we have an established system with enhanced traceability, therefore we will limit the applicable lot items for any potential compensation.
- The content of this catalog is as of April 2023

NIPPON CHEMI-CON CORPORATION
<https://www.chemi-con.co.jp/en/>



Distributed or Represented by